

General Description

FSMOS[®]

$R_{DS(ON)}$, low gate charge, fast switching and excellent avalanche characteristics. The low V_{th} series is specially optimized for synchronous rectification systems with low driving voltage.

Features

- Low $R_{DS(ON)}$ & FOM
- Extremely low switching loss
- Excellent reliability and uniformity
- Fast switching and soft recovery

Applications

- PD charger
- Motor driver
- Switching voltage regulator
- DC-DC convertor
- Switched mode power supply

Key Performance Parameters

Absolute Maximum Ratings at $T_j=25^{\circ}\text{C}$ unless otherwise noted

Parameter	Symbol	Value	Unit
Drain-source voltage	V_{DS}	60	V
Gate-source voltage	V_{GS}	± 20	V
Continuous drain current ¹⁾ , $T_C=25^{\circ}\text{C}$	I_D	60	A
Pulsed drain current ²⁾ , $T_C=25^{\circ}\text{C}$	$I_{D, pulse}$	180	A
Continuous diode forward current ¹⁾ , $T_C=25^{\circ}\text{C}$	I_S	60	A
Diode pulsed current ²⁾ , $T_C=25^{\circ}\text{C}$	$I_{S, pulse}$	180	A
Power dissipation ³⁾ , $T_C=25^{\circ}\text{C}$	P_D	31	W
Single pulsed avalanche energy ⁵⁾	E_{AS}	49	mJ
Operation and storage temperature	T_{stg}, T_j	-55 to 150	$^{\circ}\text{C}$

Thermal Characteristics

Parameter	Symbol	Value	Unit
Thermal resistance, junction-case	R	4.03	$^{\circ}\text{C/W}$
Thermal resistance, junction-ambient ⁴⁾	R	62	$^{\circ}\text{C/W}$

Electrical Characteristics at $T_j=25^{\circ}\text{C}$ unless otherwise specified

Parameter	Symbol	Min.	Typ.	Max.	Unit	Test condition
Drain-source breakdown voltage	BV_{DSS}	60			V	$V_{GS}=0\text{ V}, I_D=250\text{ A}$
Gate threshold voltage	$V_{GS(th)}$	1.3		2.4	V	$V_{DS}=V_{GS}, I_D=250\text{ A}$
Drain-source on-state resistance	$R_{DS(ON)}$		3.7	4.5		$V_{GS}=10\text{ V}, I_D=20\text{ A}$
Drain-source on-state resistance	$R_{DS(ON)}$		5.3	6.5		$V_{GS}=4.5\text{ V}, I_D=20\text{ A}$
Gate-source leakage current	I_{GSS}			100	nA	$V_{GS}=20\text{ V}$
				-100		$V_{GS}=-20\text{ V}$
Drain-source leakage current	I_{DSS}			1	A	$V_{DS}=60\text{ V}, V_{GS}=0\text{ V}$
Gate resistance	R_G		2.9			

Dynamic Characteristics

Parameter	Symbol	Min.	Typ.	Max.	Unit	Test condition
Input capacitance	C_{iss}					

Electrical Characteristics Diagrams

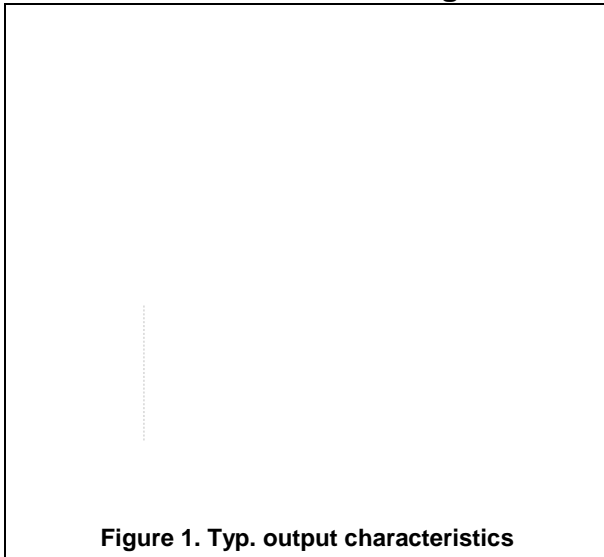

Figure 1. Typ. output characteristics

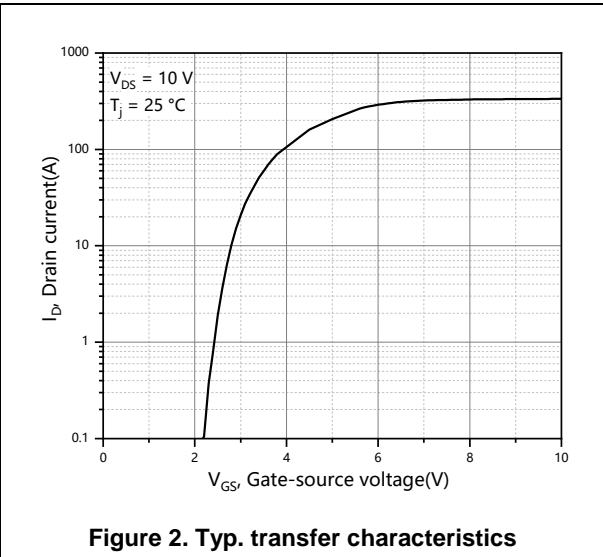

Figure 2. Typ. transfer characteristics

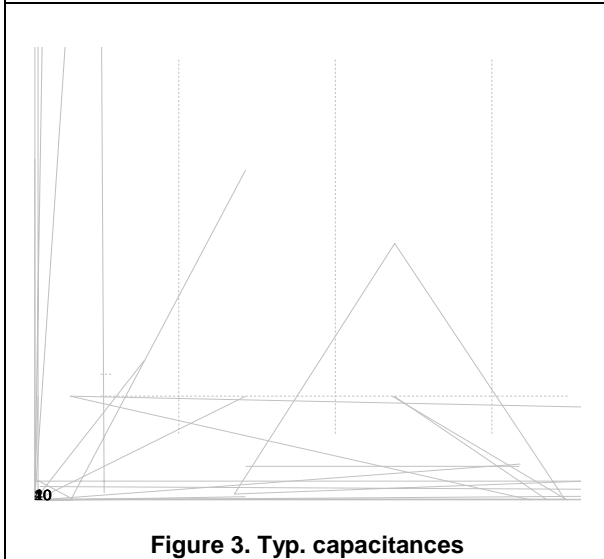

Figure 3. Typ. capacitances

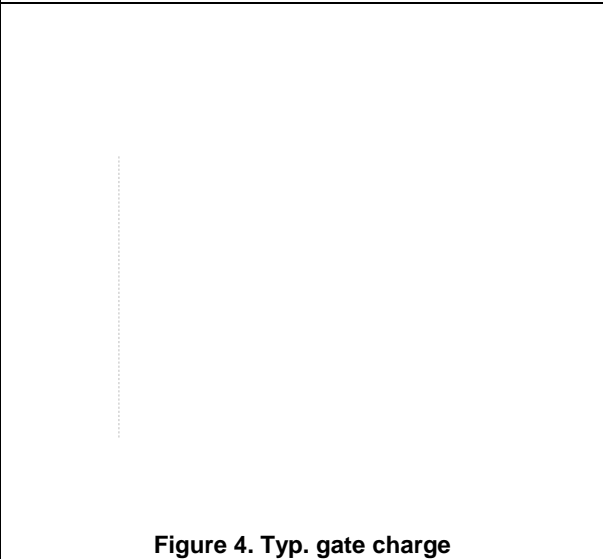

Figure 4. Typ. gate charge

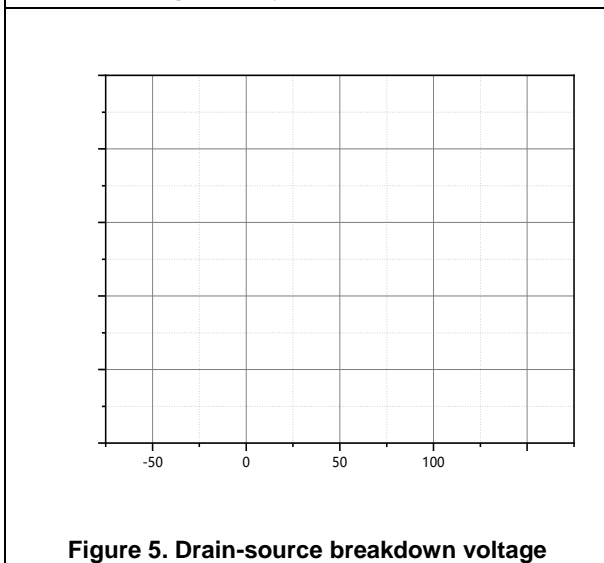

Figure 5. Drain-source breakdown voltage

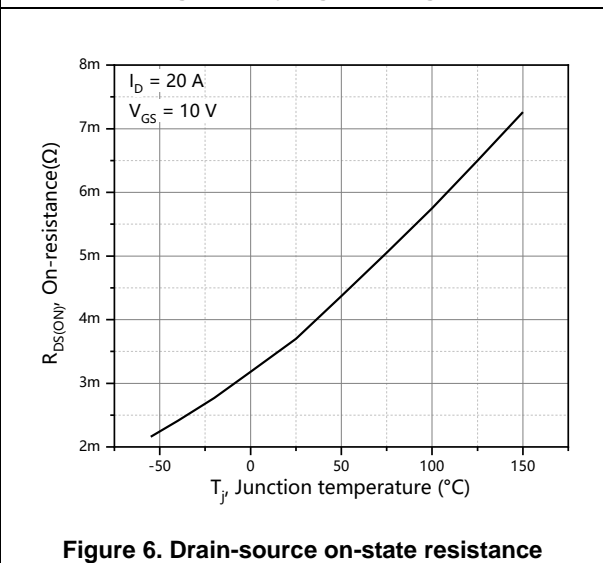
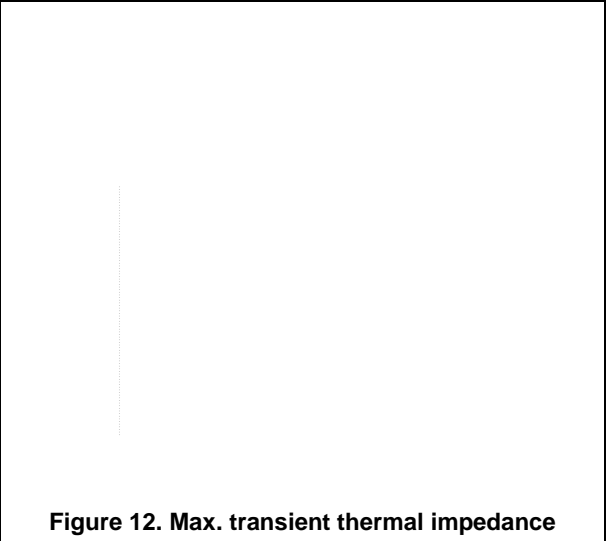
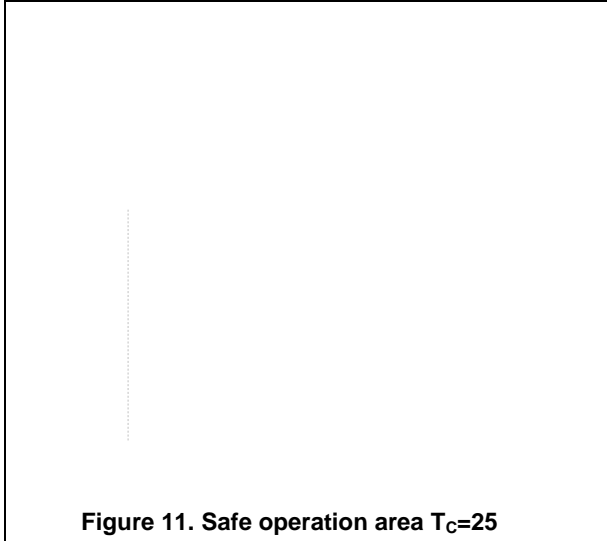
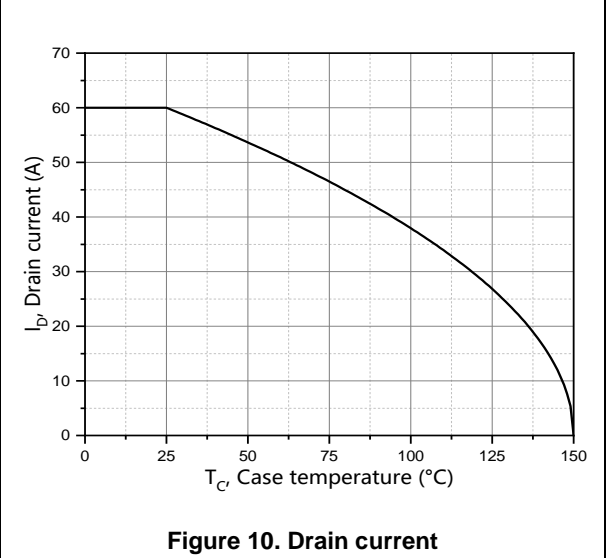
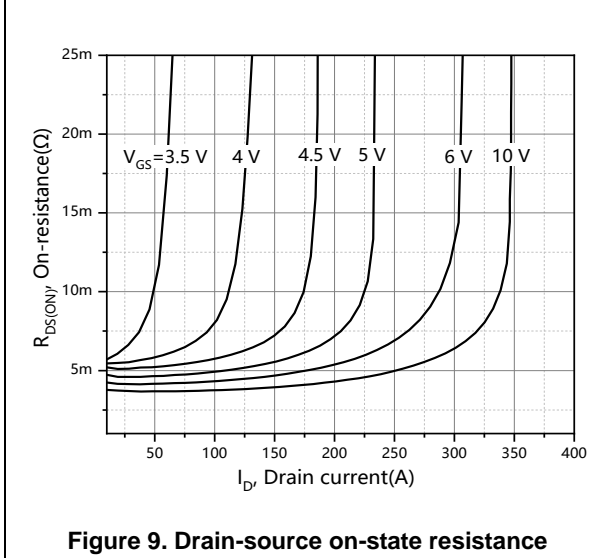
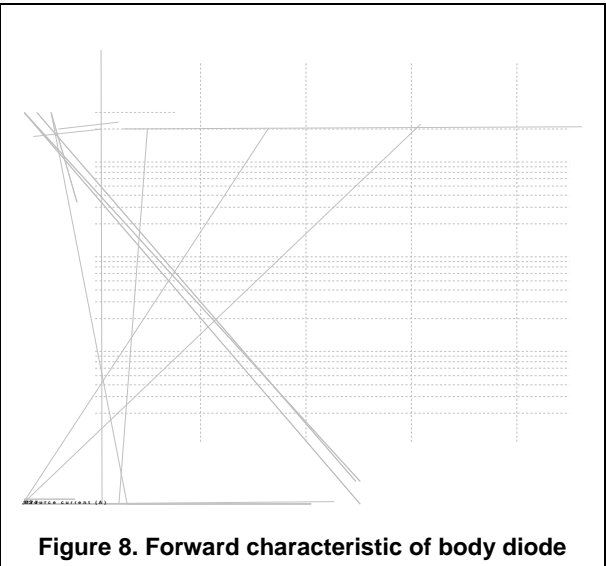
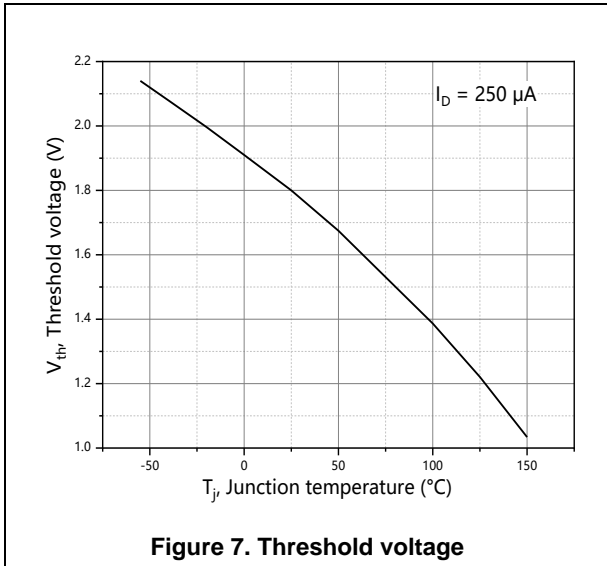

Figure 6. Drain-source on-state resistance



Test circuits and waveforms

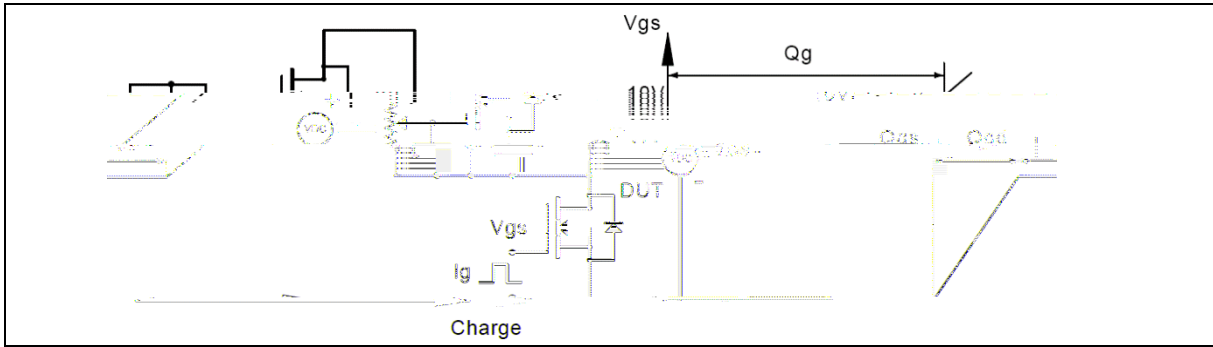

Figure 1. Gate charge test circuit & waveform

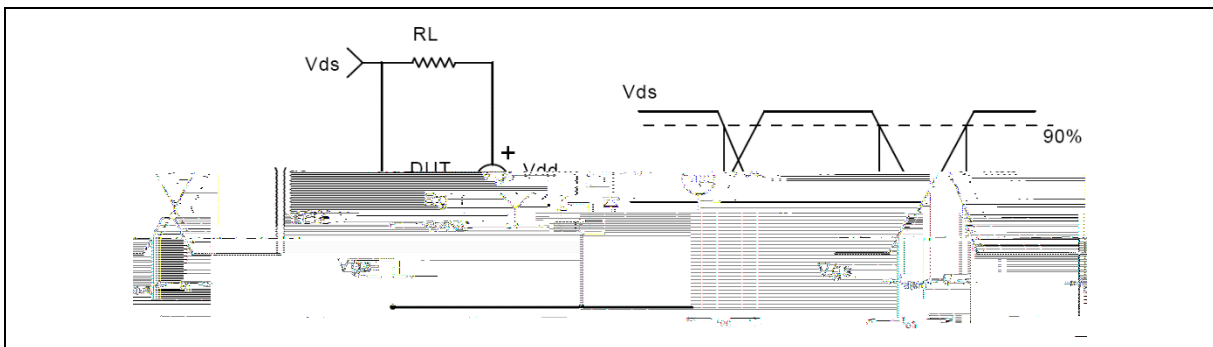

Figure 2. Switching time test circuit & waveforms

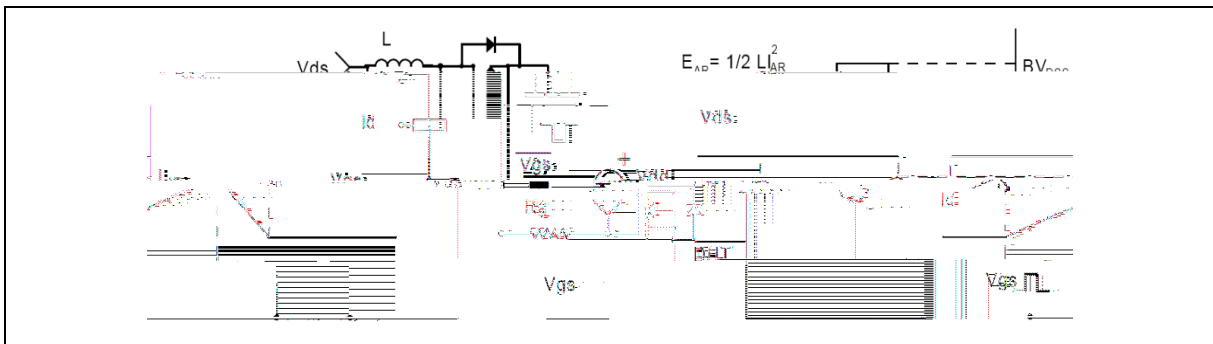

Figure 3. Unclamped inductive switching (UIS) test circuit & waveforms

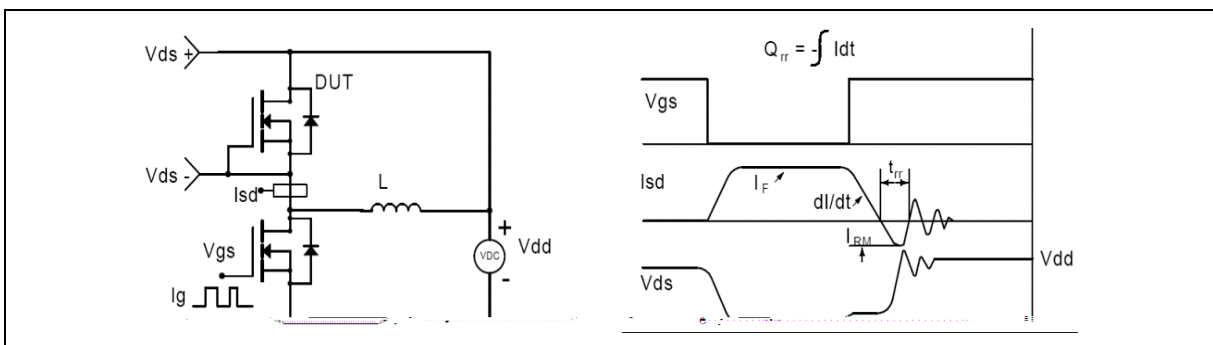

Figure 4. Diode reverse recovery test circuit & waveforms

Package Information

Symbol	mm		
	Min	Nom	Max
A	0.50	-	0.60
A1	-	-	0.005
A2	0.10	-	0.25
D	3.20	3.30	3.40
E	3.20	3.30	3.40
D1	2.80	2.90	3.00

Ordering Information

Package Type	Units/ Reel	Reels/ Inner Box	Units/ Inner Box	Inner Boxes/ Carton Box	Units/ Carton Box
PDFN3.3*3.3-X	5000	1	5000	8	40000

Product Information

Product	Package	Pb Free	RoHS	Halogen Free
SFS06R045UNF	PDFN3.3*3.3	yes	yes	yes

Legal Disclaimer

The information given in this document shall in no event be regarded as a guarantee of conditions or characteristics. With respect to any examples or hints given herein, any typical values stated herein and/or any information regarding the application of the device, Oriental Semiconductor hereby disclaims any and all warranties and liabilities of any kind, including without limitation, warranties of non-infringement of intellectual property rights of any third party.

For further information on technology, delivery terms and conditions and prices, please contact the Oriental Semiconductor