

N-channel MOSFET

Features

- Low gate charge
- 100% avalanche tested
- Improved dv/dt capability
- RoHS compliant
- Halogen free package
- JEDEC Qualification

BV_{DSS}	I_D	$R_{DS(on)}$
900V	4A	<4.0Ω

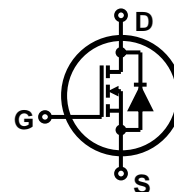
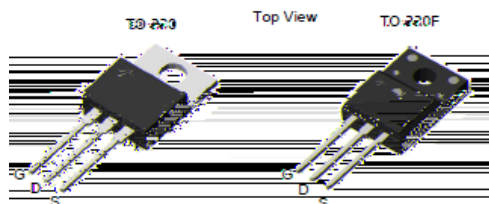

Device	Package	Marking	Remark
TMP4N90 / TMPF4N90	TO-220 / TO-220F	TMP4N90 / TMPF4N90	RoHS
TMP4N90G / TMPF4N90G	TO-220 / TO-220F	TMP4N90G / TMPF4N90G	Halogen Free

Absolute Maximum Ratings

Parameter	Symbol	TMP4N90(G)	TMPF4N90(G)	Unit	
Drain-Source Voltage	V_{DSS}	900		V	
Gate-Source Voltage	V_{GS}	30		V	
Continuous Drain Current	I_D	$T_C = 25$	14	4 *	A
		$T_C = 100$	2.22	2.22 *	A
Pulsed Drain Current (Note 1)	I_{DM}	16	16 *	A	
Single Pulse Avalanche Energy (Note 2)	E_{AS}	8.5		mJ	
Repetitive Avalanche Current (Note 1)	I_{AR}	4		A	
Repetitive Avalanche Energy (Note 1)	E_{AR}	12.3		mJ	
Power Dissipation	P_D	$T_C = 25$	123	38.7	W
		Derate above 25	0.98	0.30	W/
Peak Diode Recovery dv/dt (Note 3)	dv/dt	4.5		V/ns	
Operating Junction and Storage Temperature Range	T_J, T_{STG}	-55~150			
Maximum lead temperature for soldering purposes,	T_L	300			

* Limited only by maximum junction temperature

Thermal Characteristics

Parameter	Symbol	TMP4N90(G)	TMPF4N90(G)	Unit
Maximum Thermal resistance, Junction-to-Case	$R_{\theta JC}$	1.01	3.23	/W
Maximum Thermal resistance, Junction-to-Ambient	$R_{\theta JA}$	62.5	62.5	/W

Fig. 1 Output Characteristics

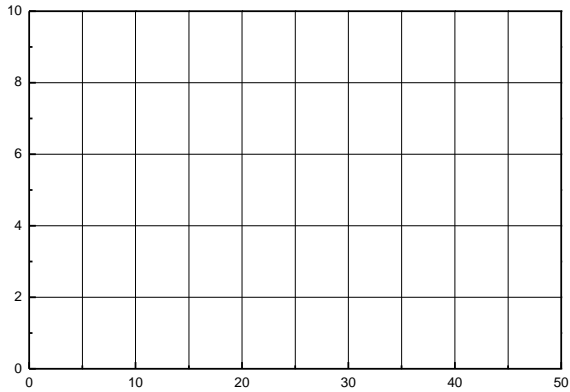

Fig. 2 Transfer Characteristics

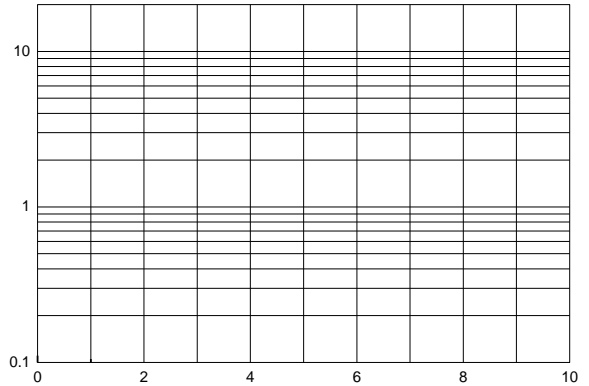

Fig. 3 On-Resistance vs. Drain Current and Gate voltage

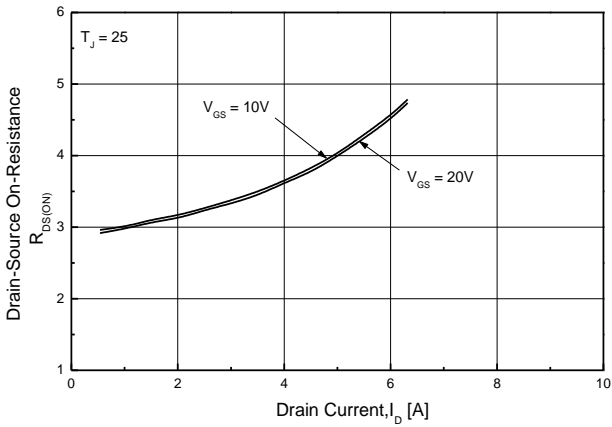

Fig. 4 Body Diode Forward Voltage vs. Source Current and Temperature

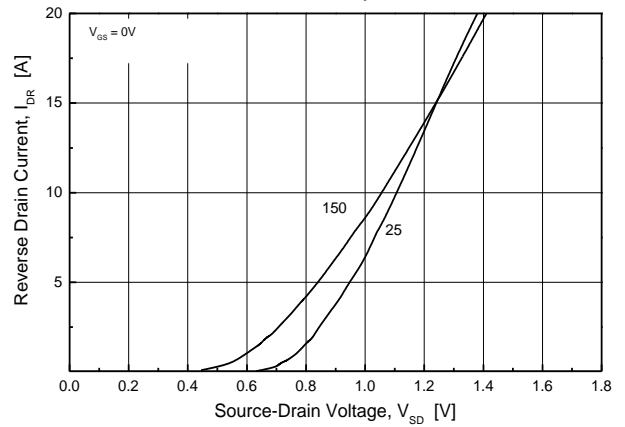

Fig. 5 Capacitance Characteristics

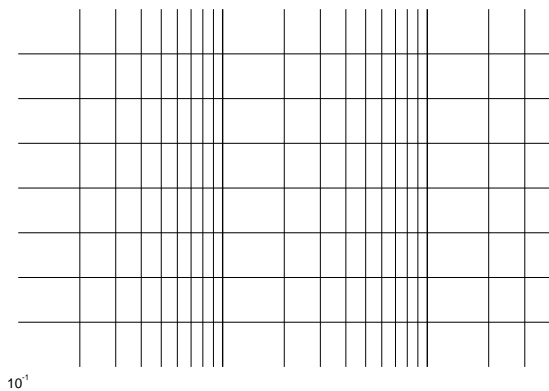

Fig. 6 Gate Charge Characteristics

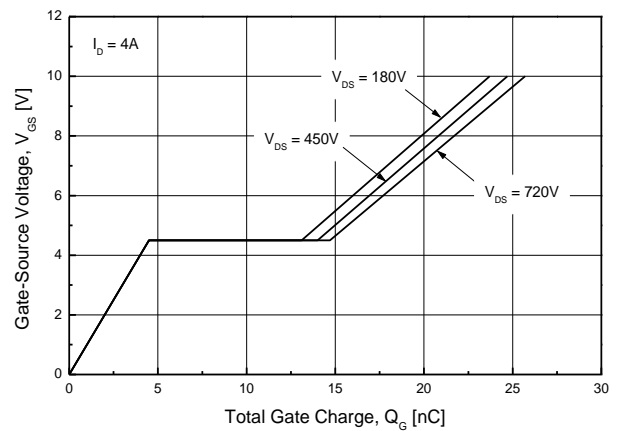

Fig. 7 Breakdown Voltage vs. Temperature

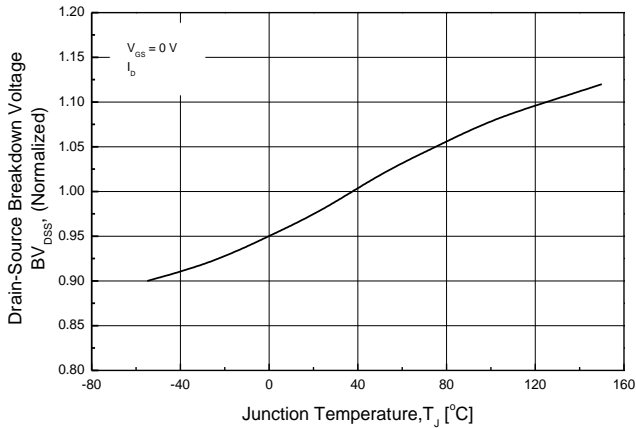

Fig. 8 On-Resistance vs. Temperature

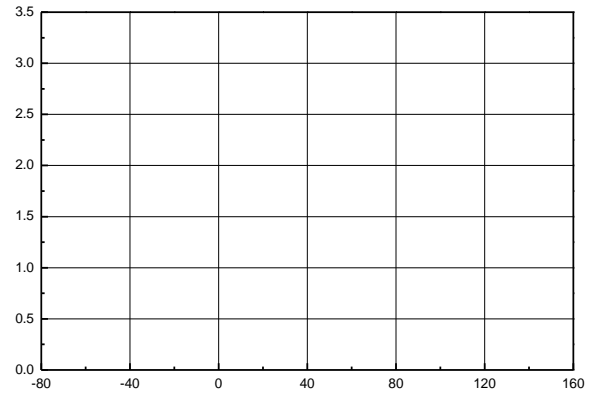

Fig. 9 Maximum Drain Current vs. Case Temperature

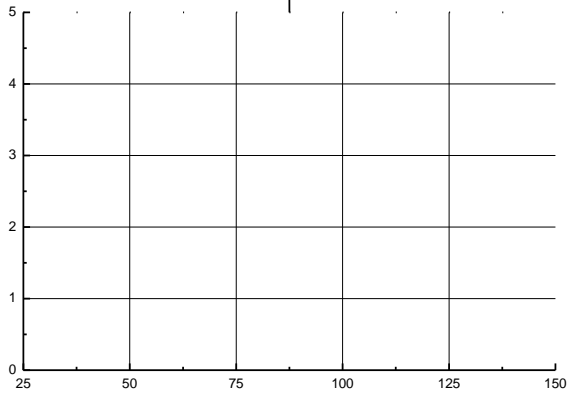

Fig. 10 Gate Threshold Voltage vs. Junction Temperature

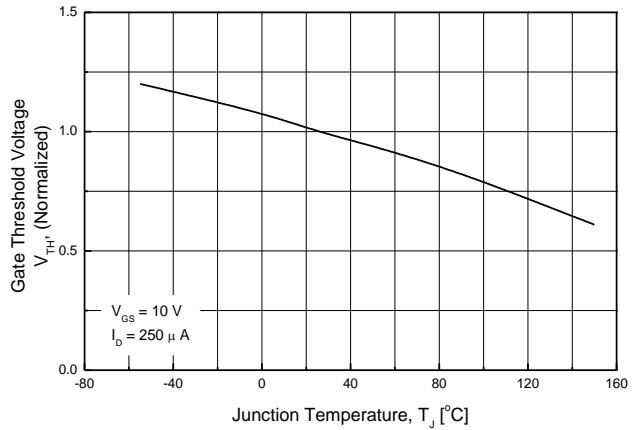

Fig. 11 Maximum Safe Operating Area

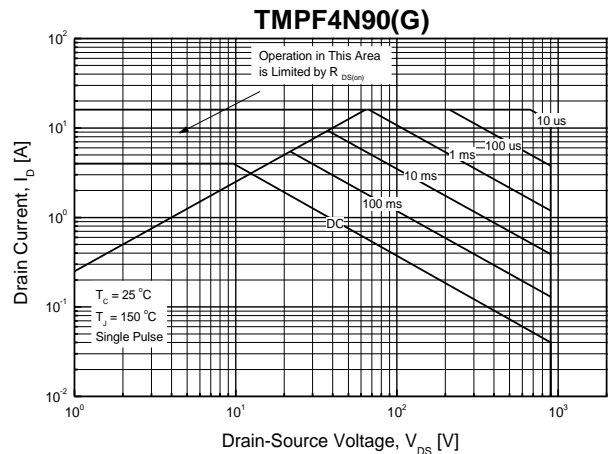
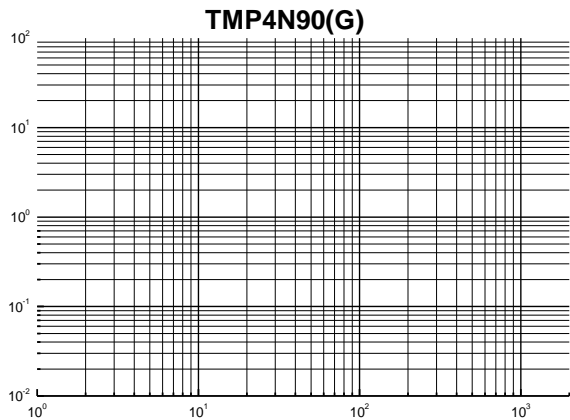
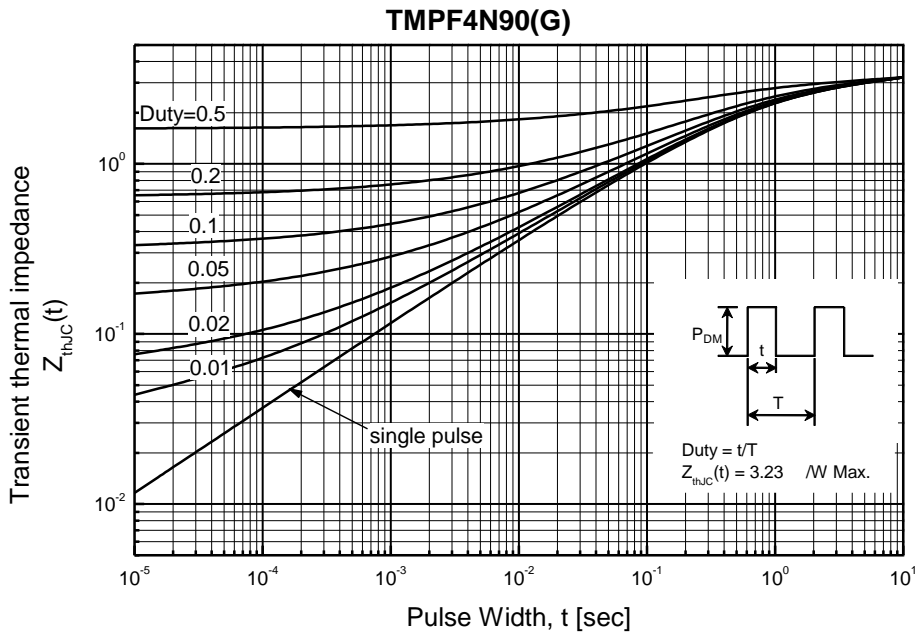
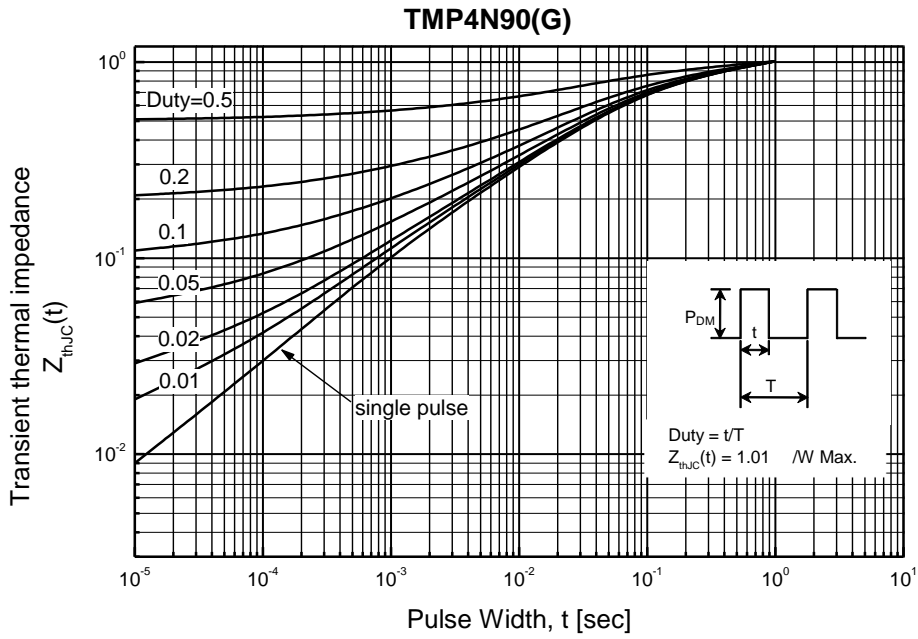
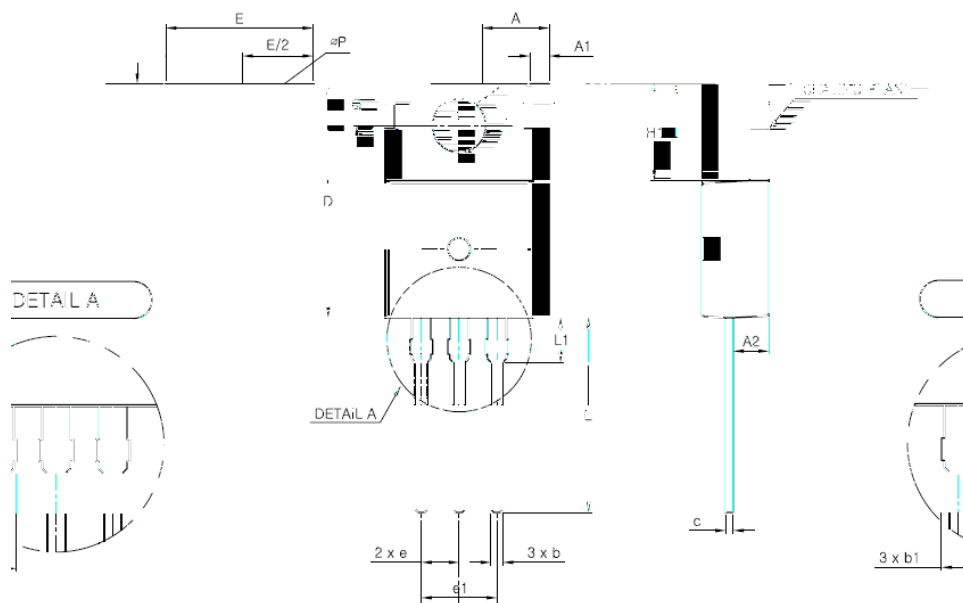
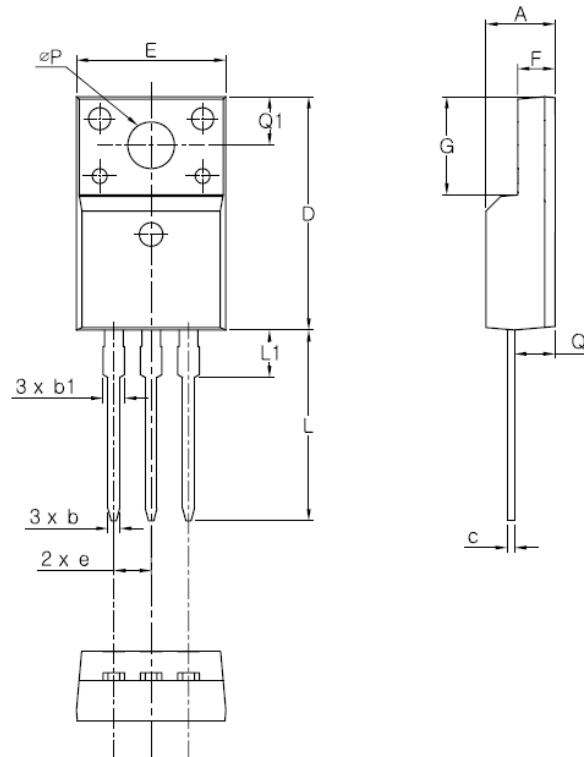

Fig. 12 Transient Thermal Response Curve



TO-220AB-3L MECHANICAL DATA

SYMBOL	MIN	MAX
A	4.30	4.70
A1	1.22	1.40
A2	2.20	2.79
b	0.70	0.91
b1	1.15	1.62
c	0.36	0.60
D	14.99	15.90
E	9.70	10.41
e	2.54 TYP	
e1	5.08 BSC	
H1	5.97	6.70
L	12.88	13.97
L1	3.31	3.81
ØP	3.40	3.88
Q	2.60	2.90

TO-220F-3L MECHANICAL DATA

SYMBOL	MIN	MAX
A	4.50	4.93
b	0.70	0.91
b1	1.15	1.47
c	0.36	0.60
D	15.67	16.07
E	6.96	10.36
e	2.54 BSC	
F	2.34	2.74
G	6.48	6.90
L	12.37	13.18
L1	2.23	3.43
Q	2.56	2.96
Q1	3.10	3.50
ØP	2.98	3.38

Disclaimer :

TRinno technology reserves the right to make changes without notice to products herein to improve reliability, performance, or design. The information given in this document is believed to be accurate and reliable. However, it shall in no event be regarded as a guarantee of conditions and characteristics. With respect to any information regarding the application of the device, TRinno technology hereby disclaims any and all warranties and liabilities of any kind, including without limitation, warranties of non-infringement of patent rights of any third party.