

Features

- Low gate charge
- 100% avalanche tested
- Improved dv/dt capability
- RoHS compliant
- Halogen free package
- JEDEC Qualification
- Improved ESD performance

BV_{DSS}	I_D	$R_{DS(on)}$
600V	4.2A	

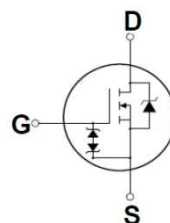
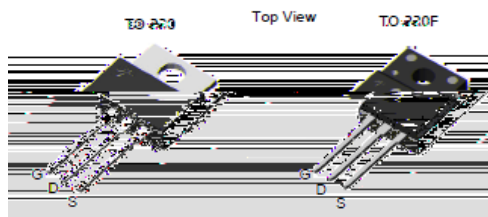

Device	Package	Marking	Remark
TMP5N60AZ / TMPF5N60AZ	TO-220 / TO-220F	TMP5N60AZ / TMPF5N60AZ	RoHS
TMP5N60AZG / TMPF5N60AZG	TO-220 / TO-220F	TMP5N60AZG / TMPF5N60AZG	Halogen Free

Absolute Maximum Ratings

Parameter	Symbol	TMP5N60AZ(G)	TMPF5N60AZ(G)	Unit	
Drain-Source Voltage	V_{DSS}	600		V	
Gate-Source Voltage	V_{GS}	30		V	
Continuous Drain Current	I_D	$T_C = 25$	4.2	4.2 *	A
		$T_C = 100$	2.71	2.71 *	A
Pulsed Drain Current (Note 1)	I_{DM}	16.8	16.8 *	A	
Single Pulse Avalanche Energy (Note 2)	E_{AS}	217		mJ	
Repetitive Avalanche Current (Note 1)	I_{AR}	4.2		A	
Repetitive Avalanche Energy (Note 1)	E_{AR}	9.84		mJ	
Power Dissipation	P_D	$T_C = 25$	98.4	32.8	W
		Derate above 25	0.787	0.263	W/
Peak Diode Recovery dv/dt (Note 3)	dv/dt	4.5		V/ns	
Operating Junction and Storage Temperature Range	T_J, T_{STG}	-55~150			
Maximum lead temperature for soldering purposes,	T_L	300			

* Limited only by maximum junction temperature

Thermal Characteristics

Parameter	Symbol	TMP5N60AZ(G)	TMPF5N60AZ(G)	Unit
Maximum Thermal resistance, Junction-to-Case	$R_{\theta JC}$	1.27	3.8	/W
Maximum Thermal resistance, Junction-to-Ambient	$R_{\theta JA}$	62.5	62.5	/W

Electrical Characteristics : $T_C=25$, unless otherwise noted

Note :

1. Repeated rating : Pulse width limited by safe operating area
2. $L=22.6\text{mH}$, $I_{AS} = 4.2\text{A}$, $V_{DD} = 50\text{V}$, $R_G = 25$, Starting $T_J= 25$
- 3 $I_{SD} = 4.2\text{A}$, di/dt μs , V_{DD} V_{DS} , Starting T

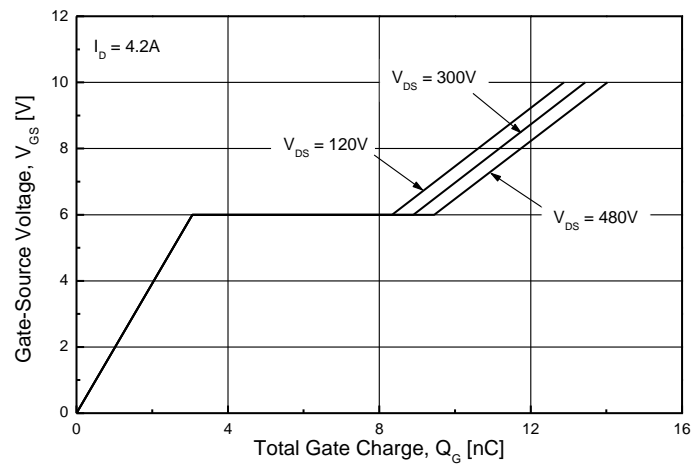
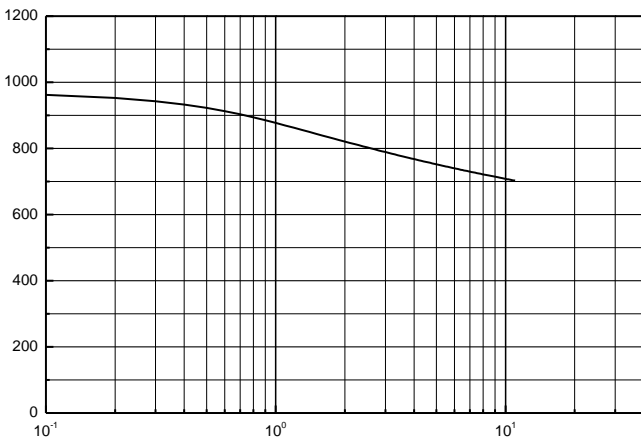
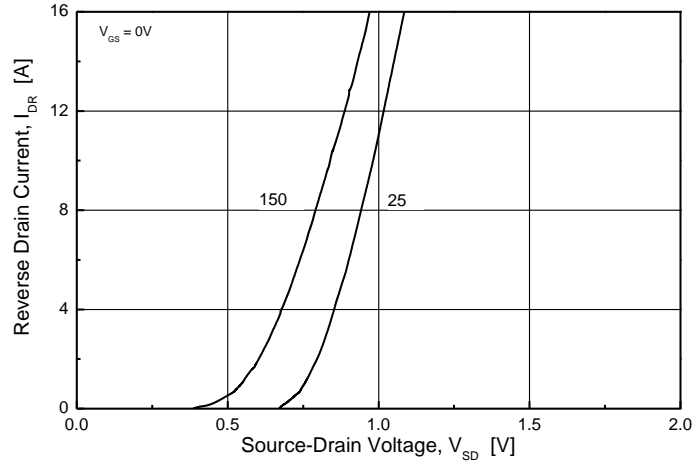
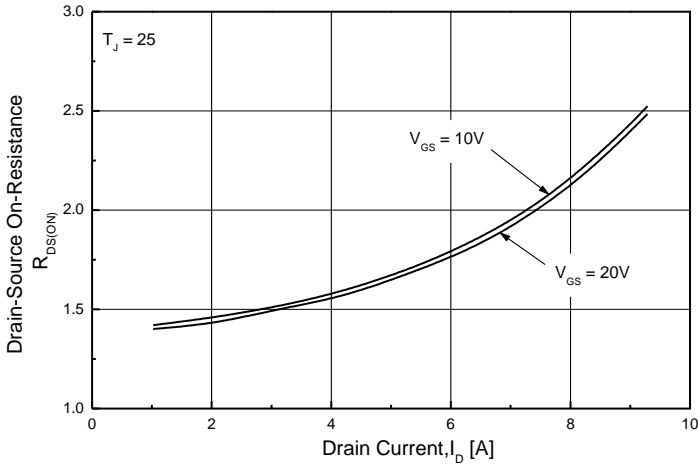
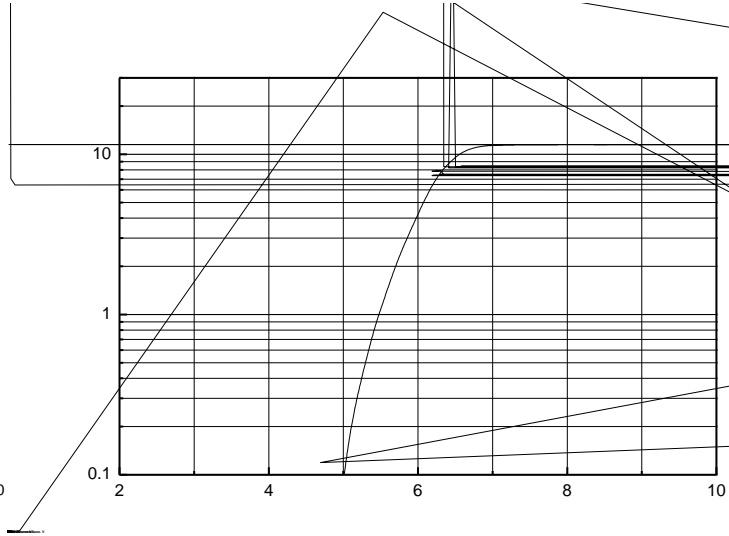
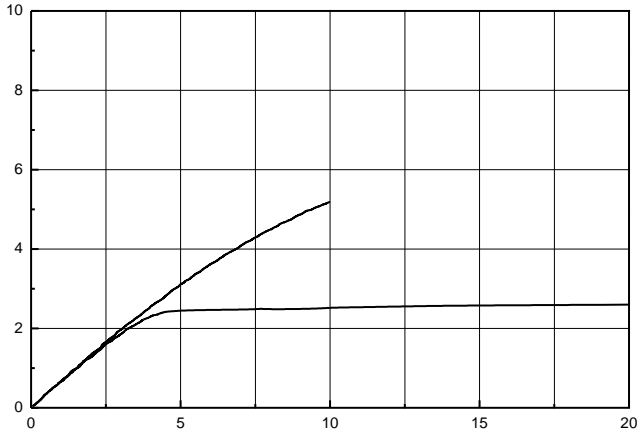

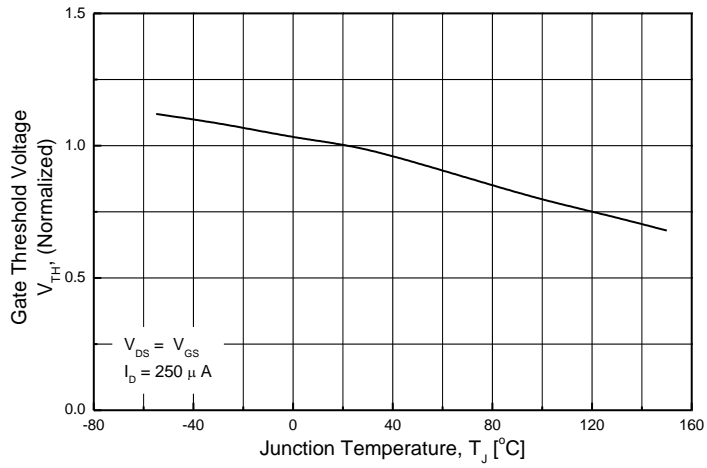
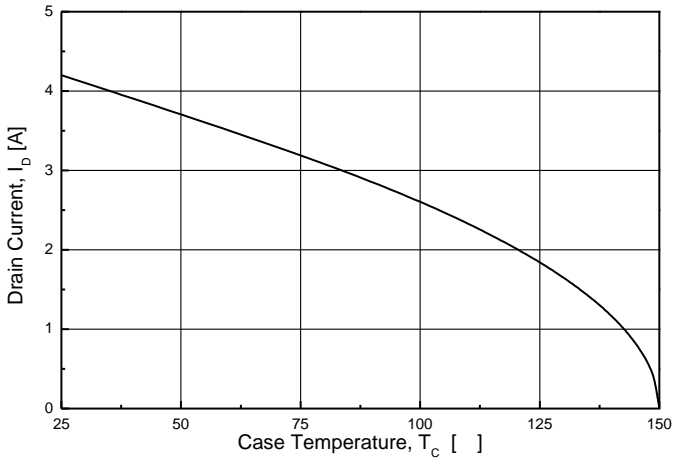
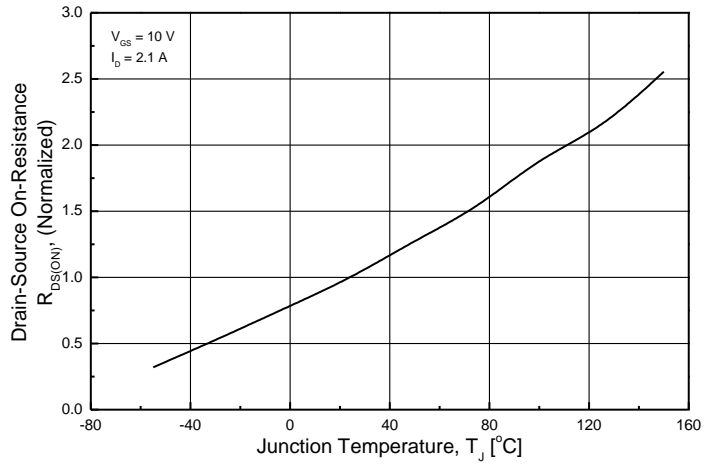
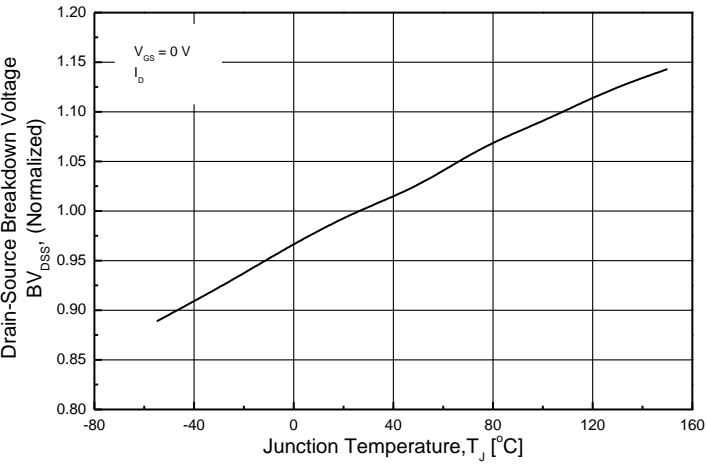

TMP5N60AZ(G)

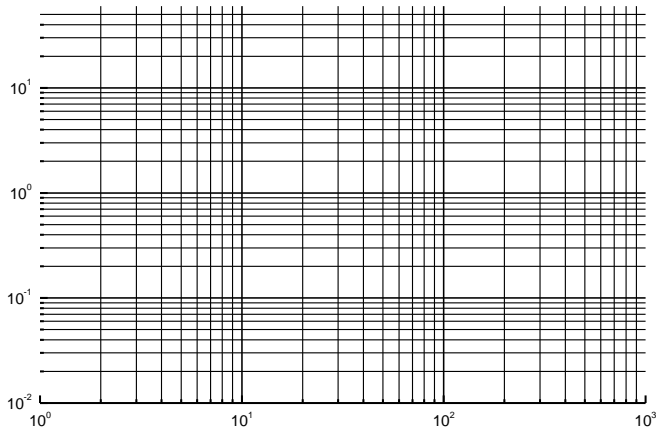

TMPF5N60AZ(G)

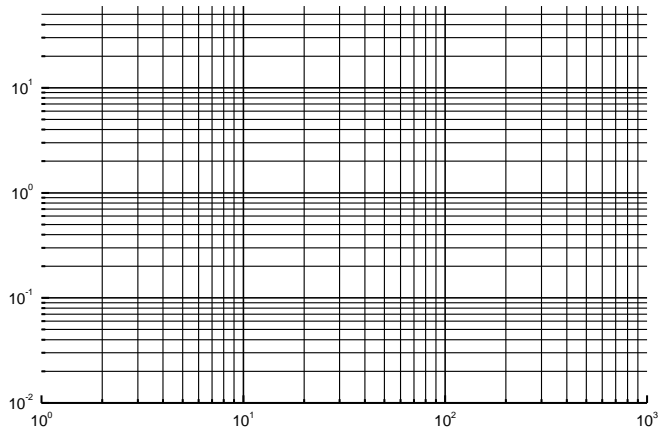

TMP5N60AZ(G)

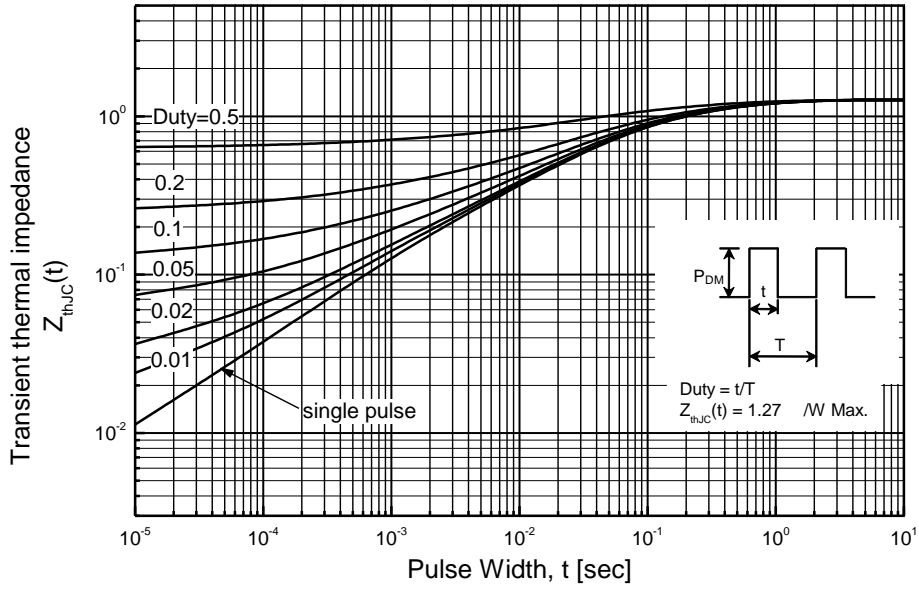

TMPF5N60AZ(G)

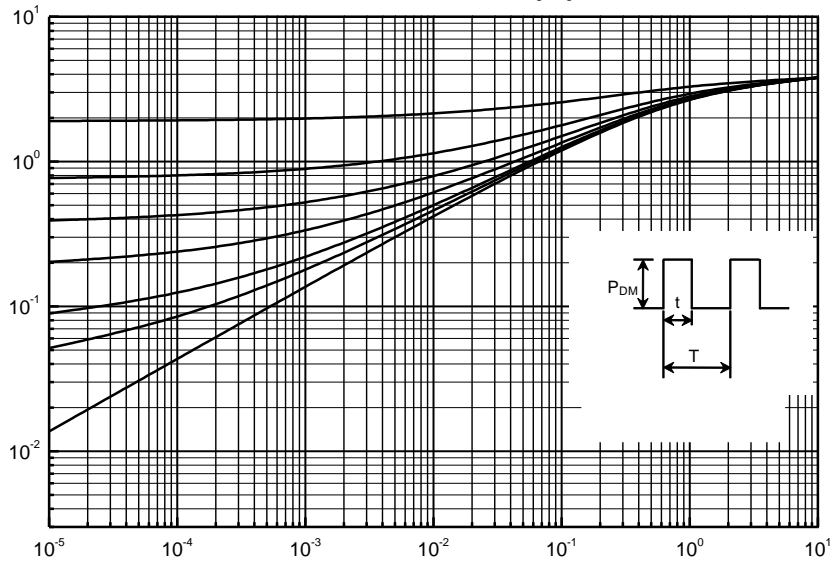

TO-220AB-3L MECHANICAL DATA

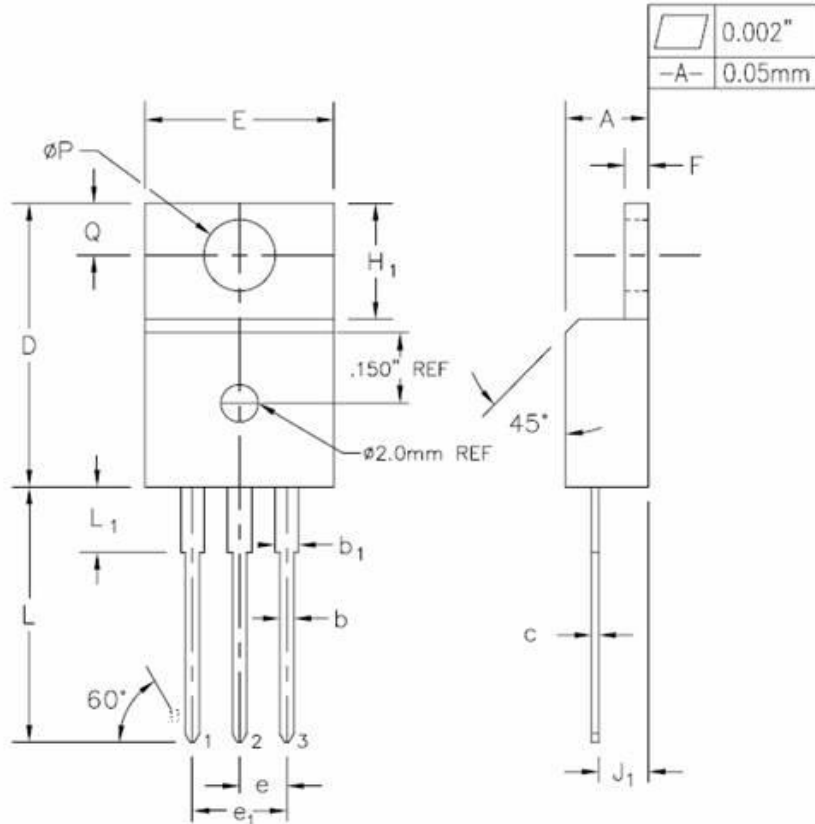

SYMBOL	INCHES		MILLIMETERS		NOTES
	MIN.	MAX.	MIN.	MAX.	
A	0.170	0.180	4.32	4.57	
b	0.028	0.036	0.71	0.91	
b ₁	0.045	0.055	1.15	1.39	
c	0.014	0.021	0.36	0.53	
D	0.590	0.610	14.99	15.49	
E	0.395	0.400	10.03	10.16	
e	0.100 TYP.		2.54 TYP.		
e ₁	0.200 BSC		5.08 BSC		
F	0.048	0.054	1.22	1.37	
H ₁	0.235	0.255	5.97	6.47	
J ₁	0.100	0.110	2.54	2.79	
L	0.530	0.550	13.47	13.97	
L ₁	0.130	0.150	3.31	3.81	
øP	0.149	0.153	3.78	3.88	
Q	0.102	0.112	2.60	2.84	

TO-220F-3L MECHANICAL DATA

