

Absolute Maximum Ratings

Electrical Characteristics : $T_C=25$, unless otherwise noted

Parameter	Symbol	Test condition	Min	Typ	Max	Units
OFF						
Drain-Source Breakdown Voltage	BV_{DSS}	$V_{GS} = 0\text{ V}, I_D = 250\ \mu\text{A}$	650	--	--	V
Zero Gate Voltage Drain Current	I_{DSS}	$V_{DS} = 650\text{ V}, V_{GS} = 0\text{ V}$	--	--	1	μA
		$V_{DS} = 520\text{ V}, T_C = 125^\circ\text{C}$	--	--	10	μA
Forward Gate-Source Leakage Current	I_{GSSF}	$V_{GS} = 30\text{ V}, V_{DS} = 0\text{ V}$	--	--	100	μA
Reverse Gate-Source Leakage Current	I_{GSSR}	$V_{GS} = -30\text{ V}, V_{DS} = 0\text{ V}$	--	--	-100	μA

ON

Gate Threshold Voltage	$V_{GS(th)}$	$V_{DS} = V_{GS}, I_D = 250\ \mu\text{A}$	3	--	5	V
Drain-Source On-Resistance	$R_{DS(on)}$	$V_{GS} = 10\text{ V}, I_D = 3.25\text{ A}$	--	1.2	1.4	Ω
Forward Transconductance ^(Note 4)	g_{FS}	$V_{DS} = 30\text{ V}, I_D = 3.25\text{ A}$	--	10	--	S

DYNAMIC

Input Capacitance	C_{iss}	$V_{DS} = 25\text{ V}, V_{GS} = 0\text{ V},$ $f = 1.0\text{ MHz}$	--	1072	--	pF
Output Capacitance	C_{oss}		--	103	--	pF
Reverse Transfer Capacitance	C_{rss}		--	12	--	pF

SWITCHING

Turn-On Delay Time ^(Note 4,5)	$t_{d(on)}$	$V_{DD} = 325\text{ V}, I_D = 6.5\text{ A},$ $R_G = 25$	--	35	--	ns
Turn-On Rise Time ^(Note 4,5)	t_r		--	46	--	ns
Turn-Off Delay Time ^(Note 4,5)	$t_{d(off)}$		--	82	--	ns
Turn-Off Fall Time ^(Note 4,5)	t_f		--	27	--	ns
Total Gate Charge ^(Note 4,5)	Q_g	$V_{DS} = 520\text{ V}, I_D = 6.5\text{ A},$ $V_{GS} = 10\text{ V}$	--	22	--	nC
Gate-Source Charge ^(Note 4,5)	Q_{gs}		--	5	--	nC
Gate-Drain Charge ^(Note 4,5)	Q_{gd}		--	10	--	nC

SOURCE DRAIN DIODE

Maximum Continuous Drain-Source Diode Forward Current	I_S	----	--	--	6.5	A
Maximum Pulsed Drain-Source Diode Forward Current	I_{SM}	----	--	--	26	A
Drain-Source Diode Forward Voltage	V_{SD}	$V_{GS} = 0\text{ V}, I_S = 6.5\text{ A}$	--	--	1.5	V
Reverse Recovery Time ^(Note 4)	t_{rr}	$V_{GS} = 0\text{ V}, I_S = 6.5\text{ A}$ $di_F / dt = 100\text{ A}/\mu\text{s}$	--	345	--	ns
Reverse Recovery Charge ^(Note 4)	Q_{rr}		--	2.6	--	μC

Note :

1. Repeated rating : Pulse width limited by safe operating area
2. $L=17.1\text{ mH}, I_{AS} = 6.5\text{ A}, V_{DD} = 50\text{ V}, R_G = 25$, Starting $T_J = 25$
3. $I_{SD} = 6.5\text{ A}, di/dt = \mu\text{s}, V_{DD} = 50\text{ V}, V_{DS} = 50\text{ V},$ Starting $T_J = 25$
5. Essentially Independent of Operating Temperature Typical Characteristics

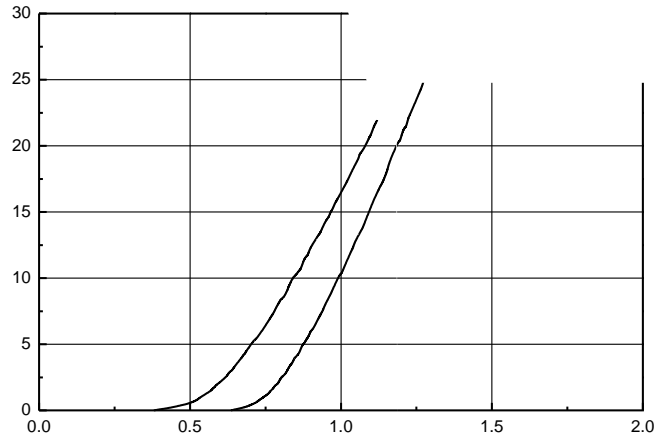
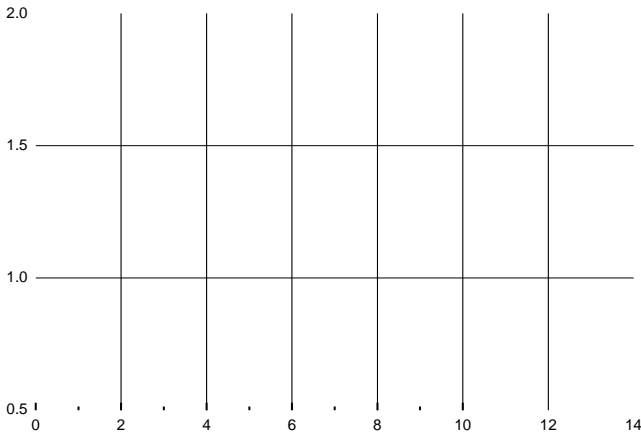
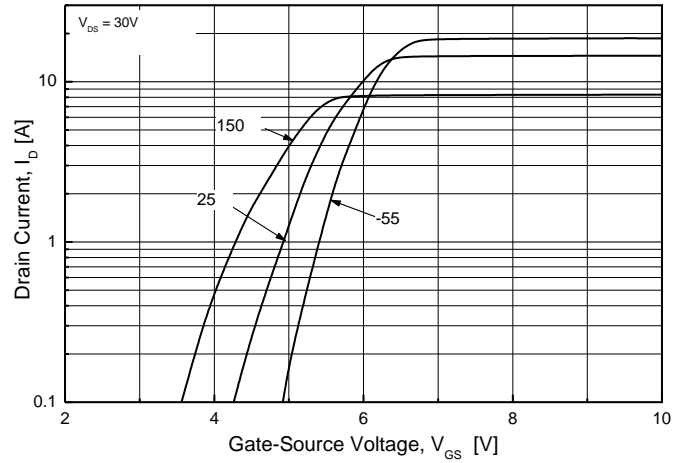
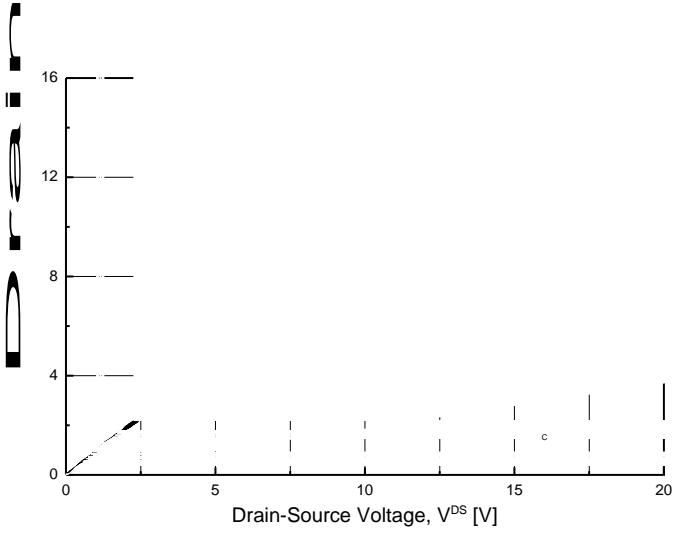

SD

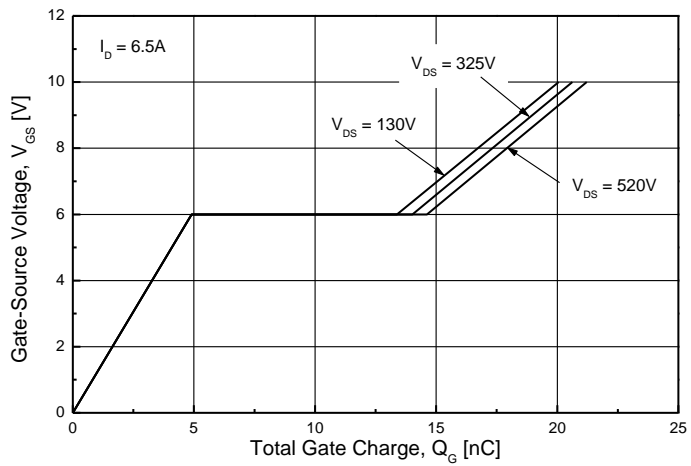

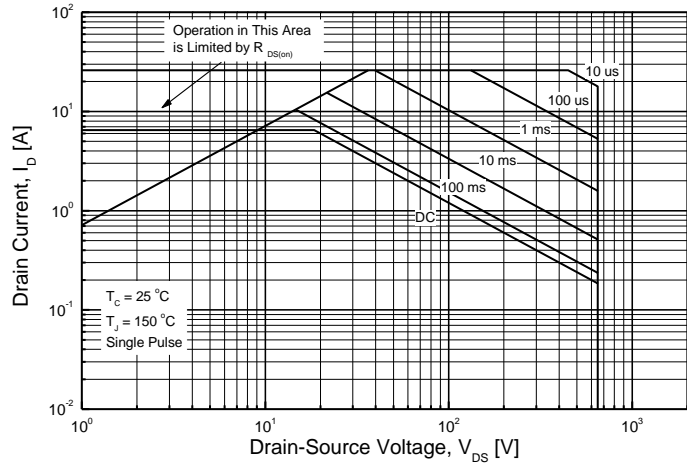
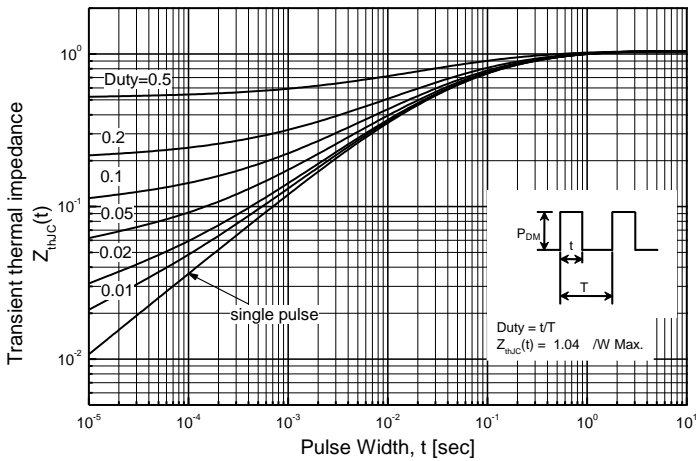
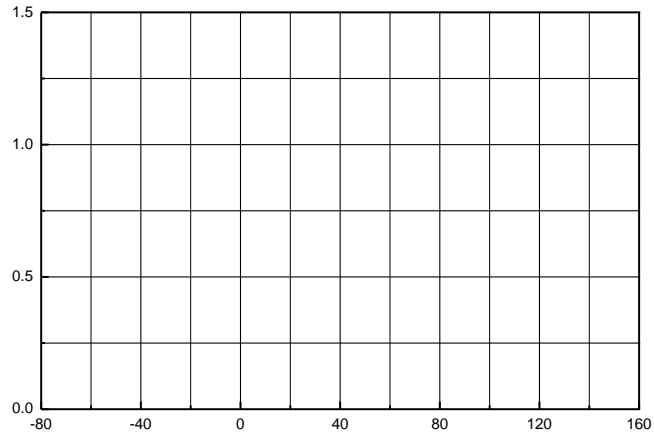
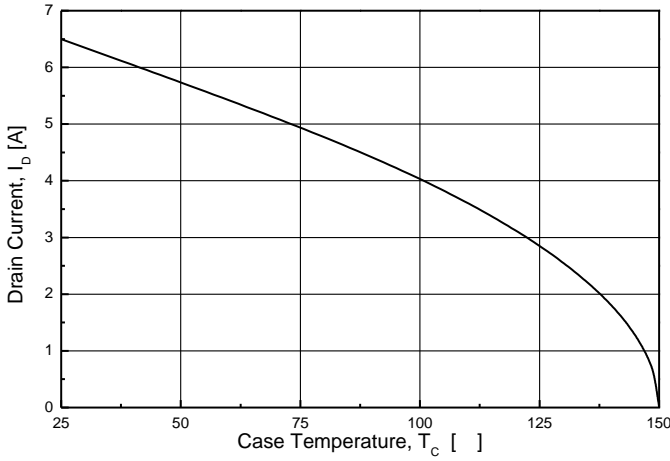
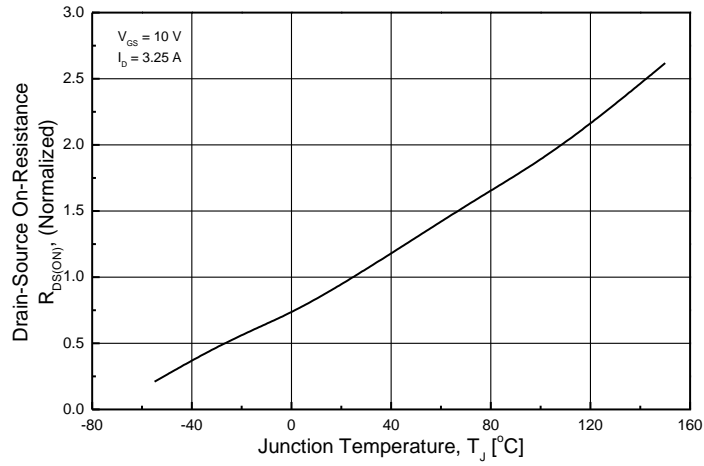
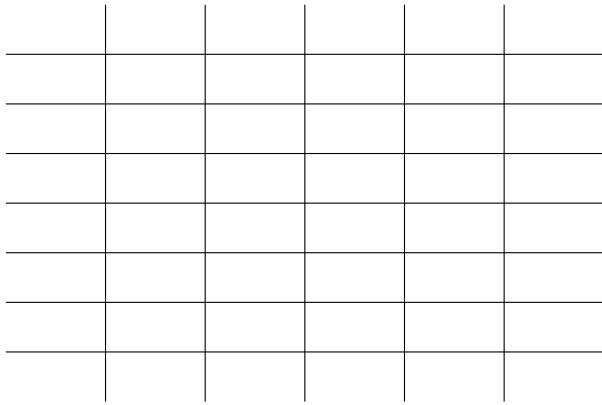

TO-252 (D-PAK) MECHANICAL DATA

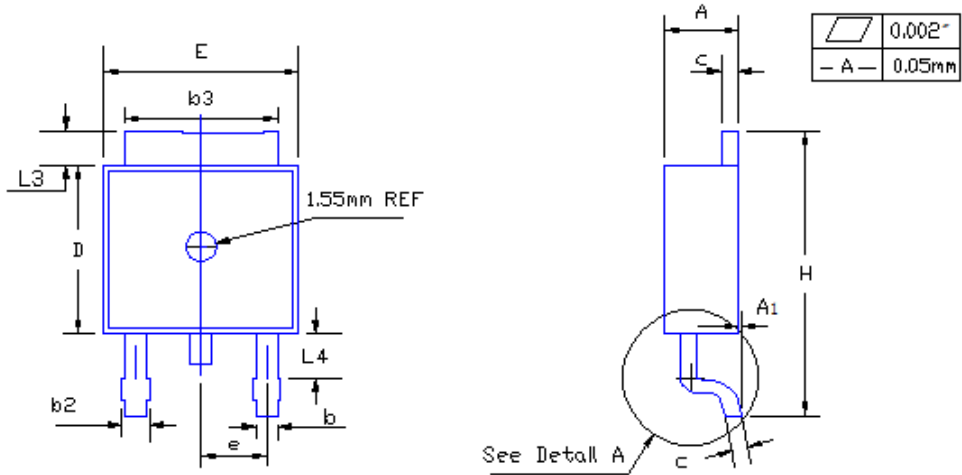

SYMBOL	MILLIMETERS	
	MIN	MAX
A	2.19	2.38
A1	—	0.13
b	0.64	0.89
b2	0.84	1.14
b3	5.21	5.46
c	0.46	0.61
D	5.97	6.22
D1	5.21	—
E	6.35	6.73
E1	4.83	—
e	2.29BSC	
H	9.65	10.41
L	1.40	1.78
L2	0.51BSC	
L3	0.89	1.27
L4	0.64	1.01
⌀	0	8

TO-251 (I-PAK) MECHANICAL DATA



SYMBOL	MILLIMETERS	
	MIN	MAX
A	2.19	2.38
A1	1.04	1.23
b	0.64	0.89
b1	0.84	1.14
b2	5.23	5.48
c	0.46	0.61
D	5.91	6.28
E	6.21	6.59
e	2.28 TYP	
L	8.89	9.65
L2	0.89	1.27