

Electrical Characteristics : $T_C=25$, unless otherwise noted

Parameter	Symbol	Test condition	Min	Typ	Max	Units
OFF						
Drain-Source Breakdown Voltage	BV_{DSS}	$V_{GS} = 0\text{ V}, I_D = 250\ \mu\text{A}$	600	--	--	V
Zero Gate Voltage Drain Current	I_{DSS}	$V_{DS} = 600\text{ V}, V_{GS} = 0\text{ V}$	--	--	1	μA
		$V_{DS} = 480\text{ V}, T_C = 125^\circ\text{C}$	--	--	10	μA
Forward Gate-Source Leakage Current	I_{GSSF}	$V_{GS} = 30\text{ V}, V_{DS} = 0\text{ V}$	--	--	100	μA
Reverse Gate-Source Leakage Current	I_{GSSR}	$V_{GS} = -30\text{ V}, V_{DS} = 0\text{ V}$	--	--	-100	μA

ON

Gate Threshold Voltage	$V_{GS(th)}$	$V_{DS} = V_{GS}, I_D = 250\ \mu\text{A}$	3	--	5	V
Drain-Source On-Resistance	$R_{DS(on)}$	$V_{GS} = 10\text{ V}, I_D = 2.0\text{ A}$	--	2.0	2.5	Ω
Forward Transconductance ^(Note 4)	g_{FS}	$V_{DS} = 30\text{ V}, I_D = 2.0\text{ A}$	--	6	--	S

DYNAMIC

Input Capacitance	C_{iss}	$V_{DS} = 25\text{ V}, V_{GS} = 0\text{ V},$ $f = 1.0\text{ MHz}$	--	545	--	pF
Output Capacitance	C_{oss}		--	61	--	pF
Reverse Transfer Capacitance	C_{rss}		--	10	--	pF

SWITCHING

Turn-On Delay Time ^(Note 4,5)	$t_{d(on)}$	$V_{DD} = 300\text{ V}, I_D = 4.0\text{ A},$ $R_G = 25\ \Omega, V_{GS} = 10\text{ V}$	--	18	--	ns
Turn-On Rise Time ^(Note 4,5)	t_r		--	27	--	ns
Turn-Off Delay Time ^(Note 4,5)	$t_{d(off)}$		--	47	--	ns
Turn-Off Fall Time ^(Note 4,5)	t_f		--	21	--	ns
Total Gate Charge ^(Note 4,5)	Q_g	$V_{DS} = 480\text{ V}, I_D = 4.0\text{ A},$ $V_{GS} = 10\text{ V}$	--	12	--	nC
Gate-Source Charge ^(Note 4,5)	Q_{gs}		--	3	--	nC
Gate-Drain Charge ^(Note 4,5)	Q_{gd}		--	6	--	nC

SOURCE DRAIN DIODE

Maximum Continuous Drain-Source Diode Forward Current	I_S	----	--	--	4	A
Maximum Pulsed Drain-Source Diode Forward Current	I_{SM}	----	--	--	16	A
Drain-Source Diode Forward Voltage	V_{SD}	$V_{GS} = 0\text{ V}, I_S = 4.0\text{ A}$	--	--	1.5	V
Reverse Recovery Time ^(Note 4)	t_{rr}	$V_{GS} = 0\text{ V}, I_S = 4.0\text{ A}$ $di_F / dt = 100\text{ A}/\mu\text{s}$	--	316	--	ns
Reverse Recovery Charge ^(Note 4)	Q_{rr}		--	1.2	--	μC

Note :

1. Repeated rating : Pulse width limited by safe operating area
2. $L=22\text{mH}, I_{AS} = 4.0\text{A}, V_{DD} = 50\text{V}, R_G = 25\ \Omega$, Starting $T_J = 25$
3. $I_{SD} = 4.0\text{A}, di/dt = 100\ \mu\text{s}, V_{DD} = 50\text{V}, V_{DS} = 480\text{V}$, Starting $T_J = 25$
5. Essentially Independent of Operating Temperature Typical Characteristics



TMP4N60AZ(G)/TMPF4N60AZ(G)

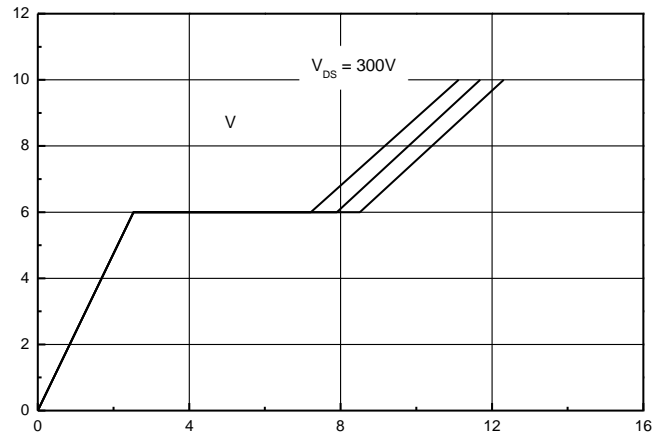
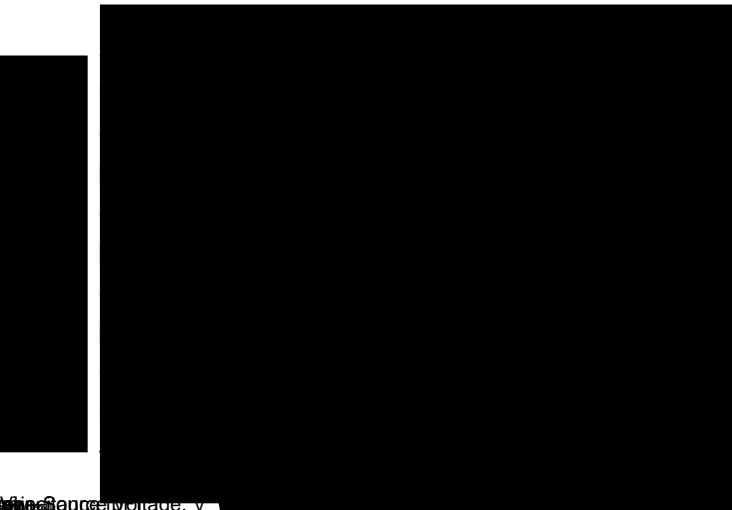
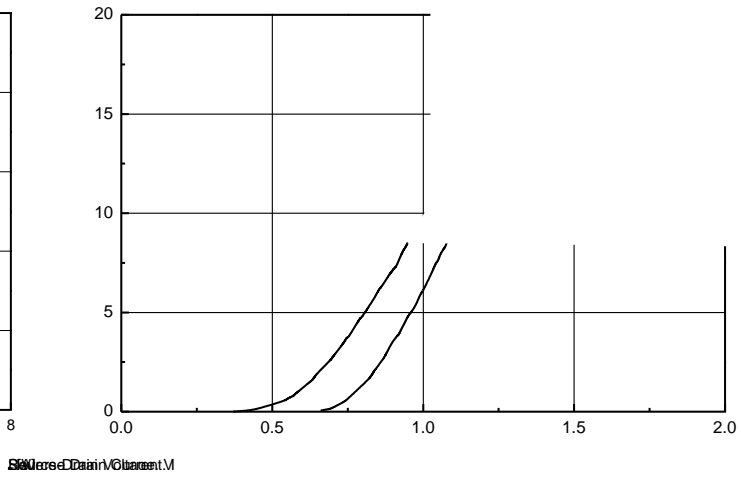
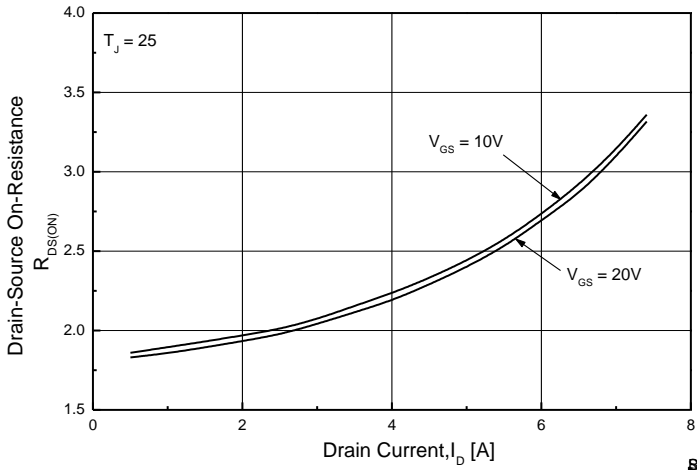
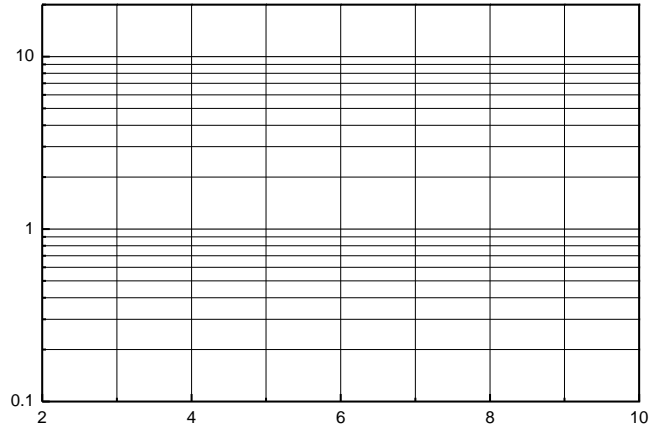
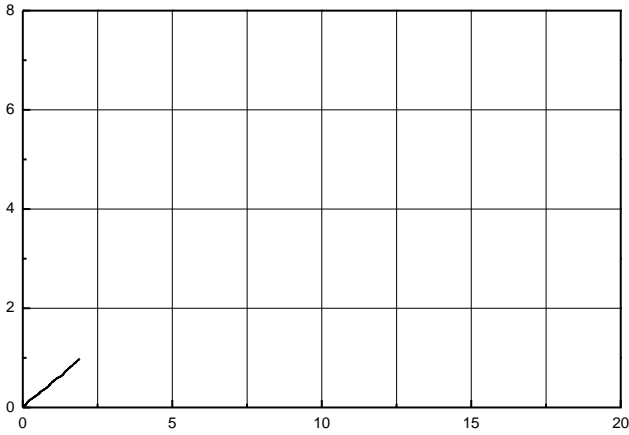

TMP4N60AZ(G)/TMPF4N60AZ(G)

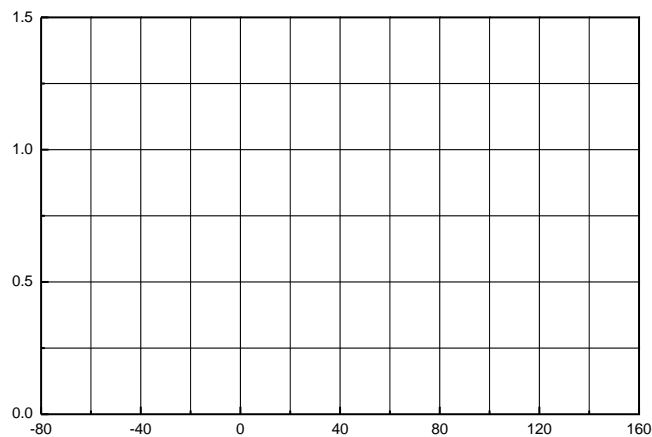
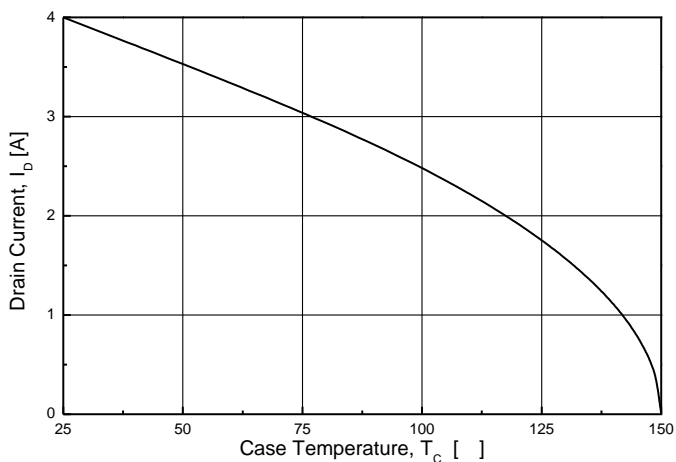
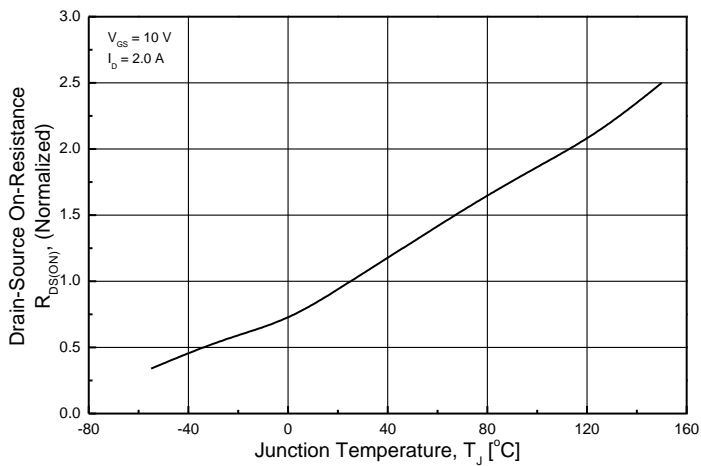
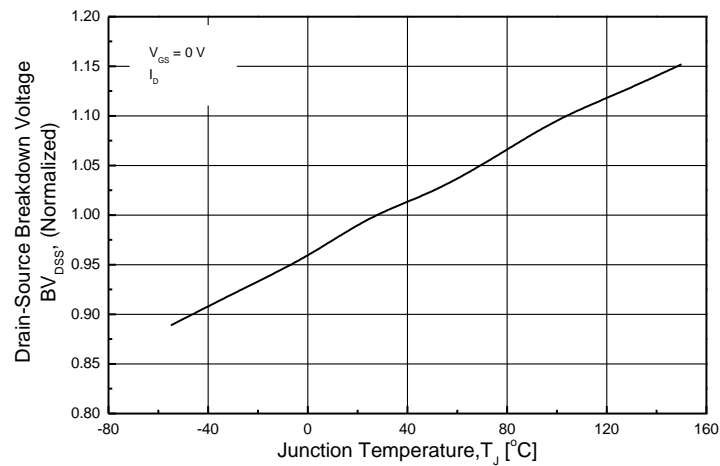

TMP4N60AZ(G)

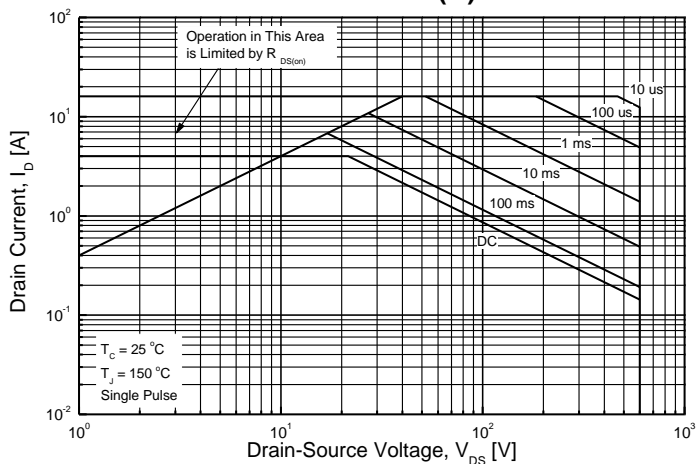

TMPF4N60AZ(G)

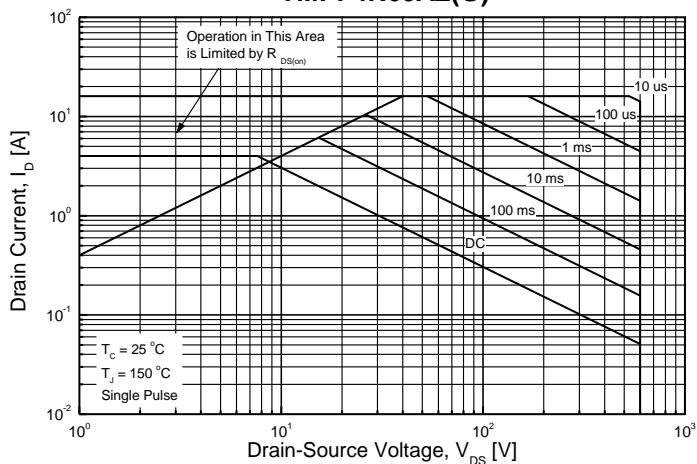



TMP4N60AZ(G)



TMPF4N60AZ(G)

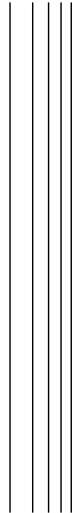

TO-220AB-3L MECHANICAL DATA

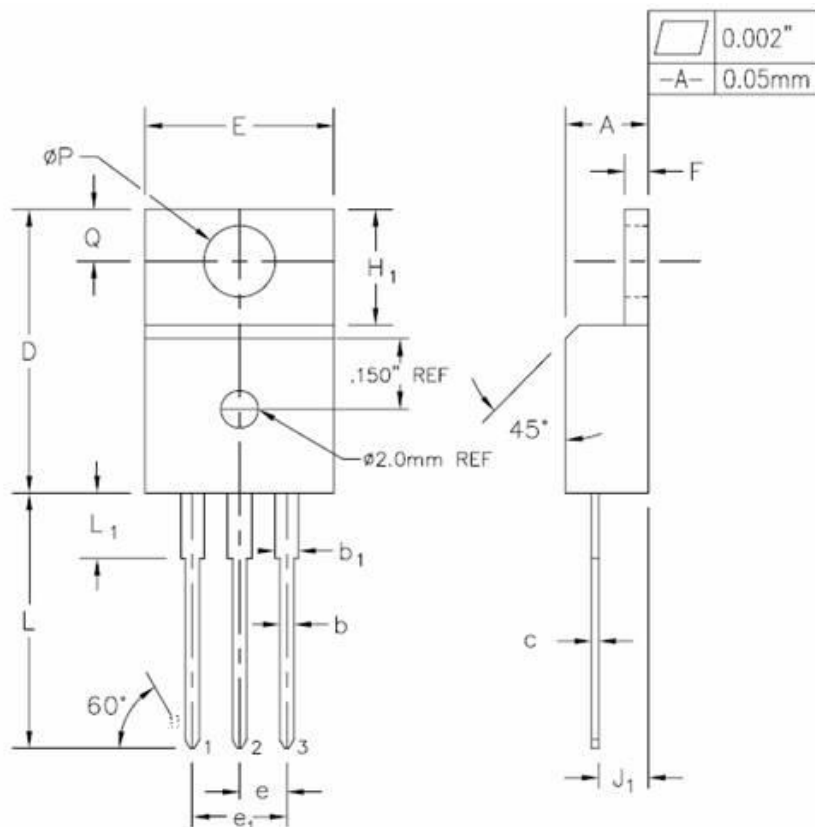

SYMBOL	INCHES		MILLIMETERS		NOTES
	MIN.	MAX.	MIN.	MAX.	
A	0.170	0.180	4.32	4.57	
b_1	0.028	0.036	0.71	0.91	
b	0.045	0.055	1.15	1.39	
c	0.014	0.021	0.36	0.53	
D	0.590	0.610	14.99	15.49	
E	0.395	0.410	10.03	10.41	
e	0.100 TYP.		2.54 TYP.		
e_1	0.200 BSC		5.08 BSC		
F_1	0.048	0.054	1.22	1.37	
H_1	0.235	0.255	5.97	6.47	
J_1	0.100	0.110	2.54	2.79	
L	0.530	0.550	13.47	13.97	
L_1	0.130	0.150	3.31	3.81	
ϕP	0.149	0.153	3.78	3.88	
Q	0.102	0.112	2.60	2.84	

TO-220F-3L MECHANICAL DATA

