

Electrical Characteristics : $T_C=25E$, unless otherwise noted

Parameter	Symbol	Test condition	Min	Typ	Max	Units
OFF						
Drain-Source Breakdown Voltage	BV_{DSS}	$V_{GS} = 0 V, I_D = 250 \mu A$	800	--	--	V
Zero Gate Voltage Drain Current	I_{DSS}	$V_{DS} = 800 V, V_{GS} = 0 V$	--	--	10	μA
		$V_{DS} = 640 V, T_C = 125^\circ C$	--	--	100	μA
Forward Gate-Source Leakage Current	I_{GSSF}	$V_{GS} = 30 V, V_{DS} = 0 V$	--	--	100	nA
Reverse Gate-Source Leakage Current	I_{GSSR}	$V_{GS} = -30 V, V_{DS} = 0 V$	--	--	-100	nA

ON						
Gate Threshold Voltage	$V_{GS(th)}$	$V_{DS} = V_{GS}, I_D = 250 \mu A$	2	--	4	V
Drain-Source On-Resistance	$R_{DS(on)}$	$V_{GS} = 10 V, I_D = 2 A$	--	2.5	3.0	Ω
Forward Transconductance (Note 4)	g_{FS}	$V_{DS} = 30 V, I_D = 2 A$	--	3.7	--	S

DYNAMIC						
Input Capacitance	C_{iSS}	$V_{DS} = 25 V, V_{GS} = 0 V,$ $f = 1.0 MHz$	--	1020	--	pF
Output Capacitance	C_{oSS}		--	77	--	pF
Reverse Transfer Capacitance	C_{rSS}		--	10.3	--	pF

SWITCHING						
Turn-On Delay Time (Note 4,5)	$t_{d(on)}$	$V_{DD} = 400 V, I_D = 4 A,$ $R_G = 25 \Omega$	--	22	--	ns
Turn-On Rise Time (Note 4,5)	t_r		--	25	--	ns
Turn-Off Delay Time (Note 4,5)	$t_{d(off)}$		--	84	--	ns
Turn-Off Fall Time (Note 4,5)	t_f		--	27	--	ns
Total Gate Charge (Note 4,5)	Q_g	$V_{DS} = 640V, I_D = 4 A,$ $V_{GS} = 10 V$	--	21	--	nC
Gate-Source Charge (Note 4,5)	Q_{gs}		--	3.2	--	nC
Gate-Drain Charge (Note 4,5)	Q_{gd}		--	7.8	--	nC

SOURCE DRAIN DIODE						
Maximum Continuous Drain-Source Diode Forward Current	I_S	---	--	--	4	A
Maximum Pulsed Drain-Source Diode Forward Current	I_{SM}	---	--	--	16	A
Drain-Source Diode Forward Voltage	V_{SD}	$V_{GS} = 0 V, I_S$				

Note :

1. Repeated rating : Pulse width limited by safe operating area
2. $L = 8.9mH, I_{AS} = 4A, V_{DD} = 50V, R_G = 25\Omega, \text{Starting } T_J = 25 E$
3. $I_{SD} \leq 4A, di/dt \leq 200A/\mu s, V_{DD} \leq BV_{DS}, \text{Starting } T_J = 25 E$
4. Pulse Test : Pulse width $\leq 300\mu s, \text{Duty Cycle } \leq 2\%$
5. Essentially Independent of Operating Temperature Typical Characteristics

TMP4N80/TMPF4N80

TMP4N80G/TMPF4N80G

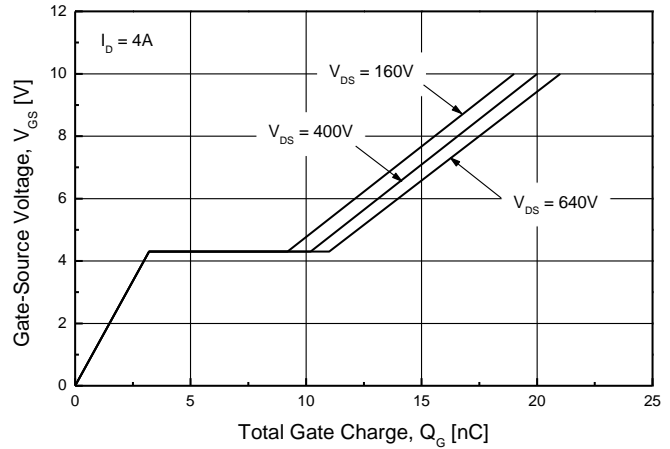
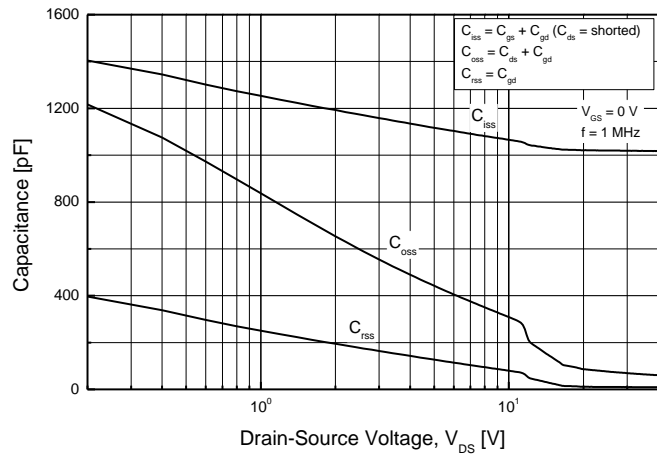
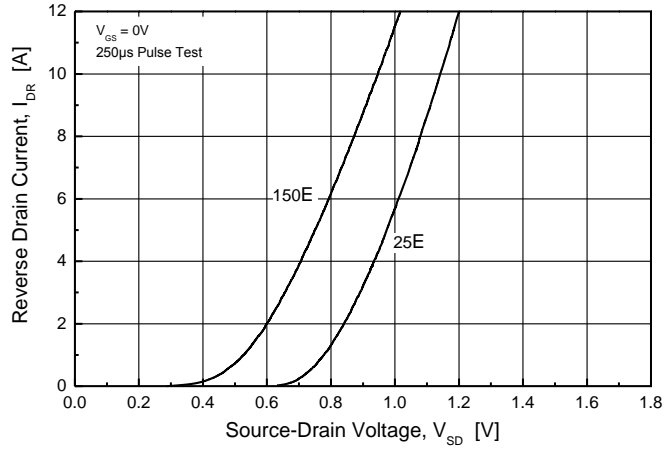
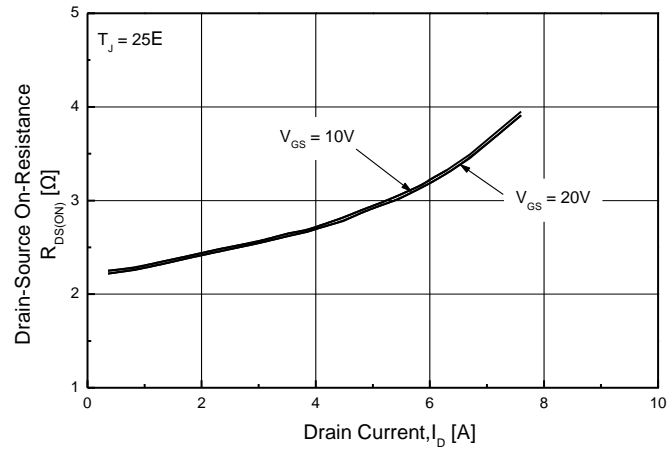
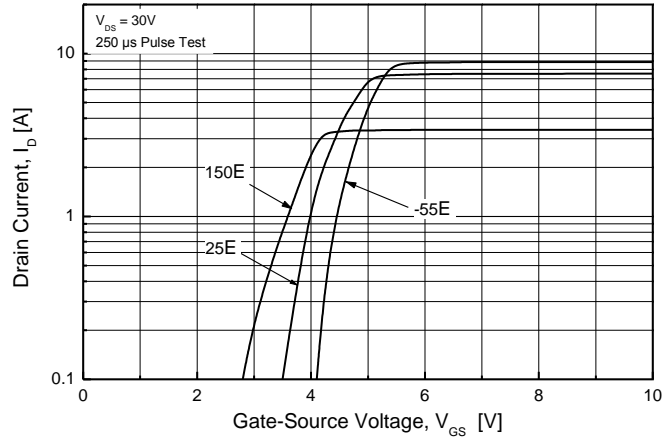
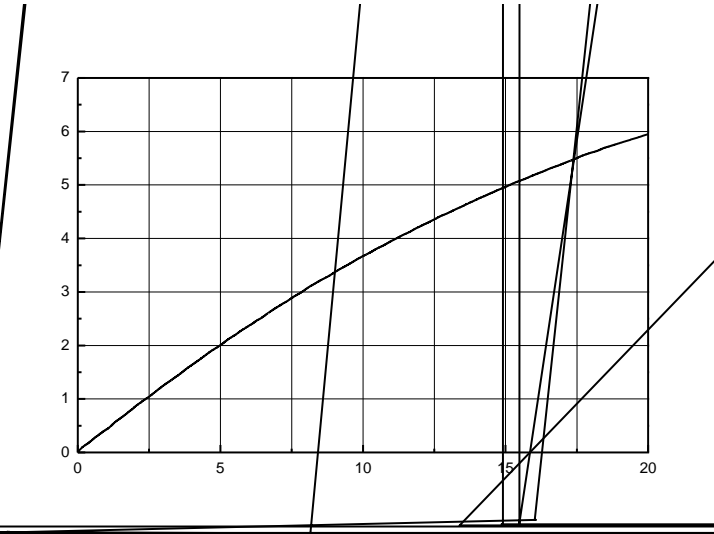



TMP4N80/TMPF4N80

TMP4N80G/TMPF4N80G

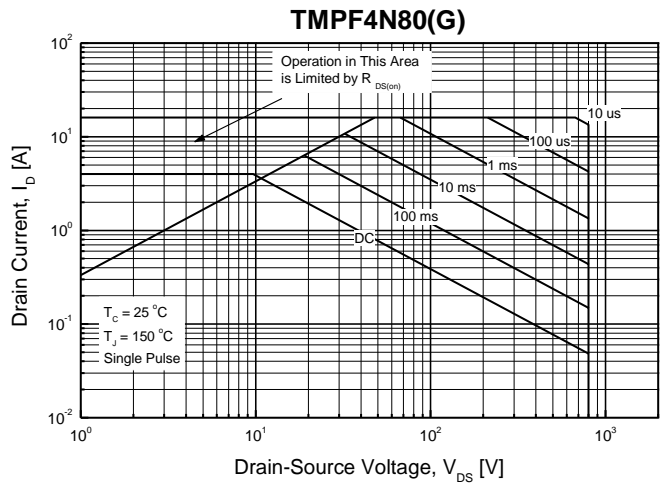
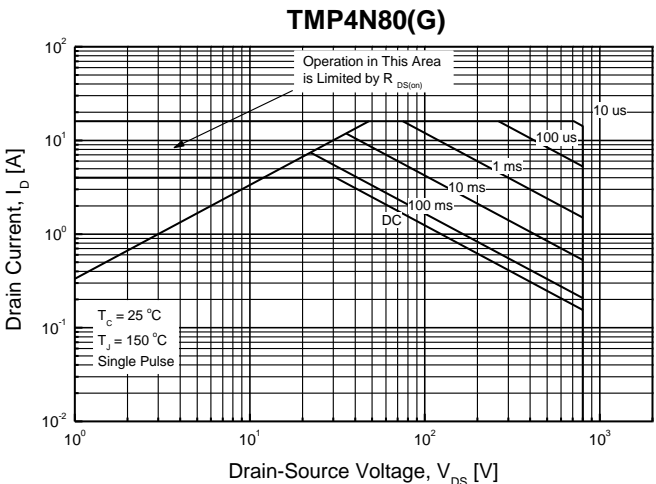
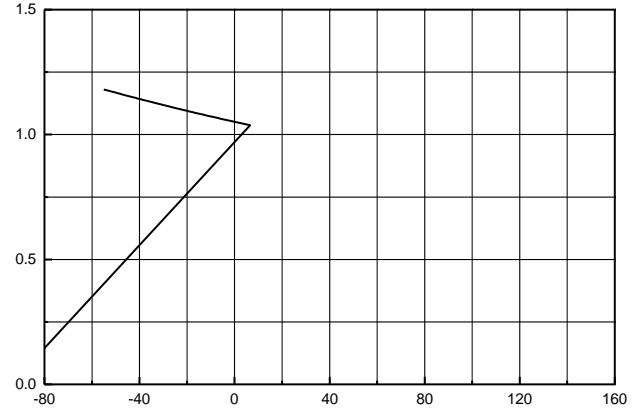
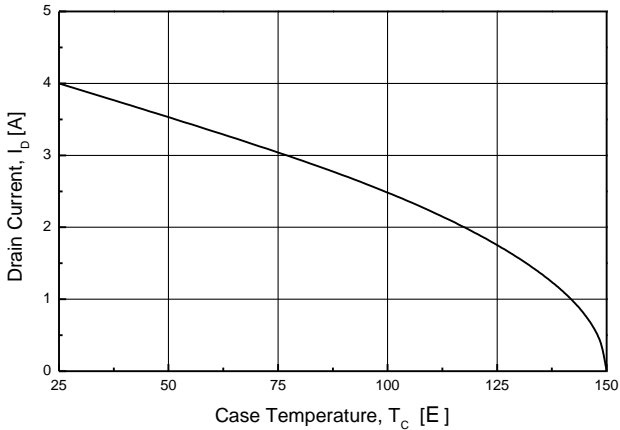
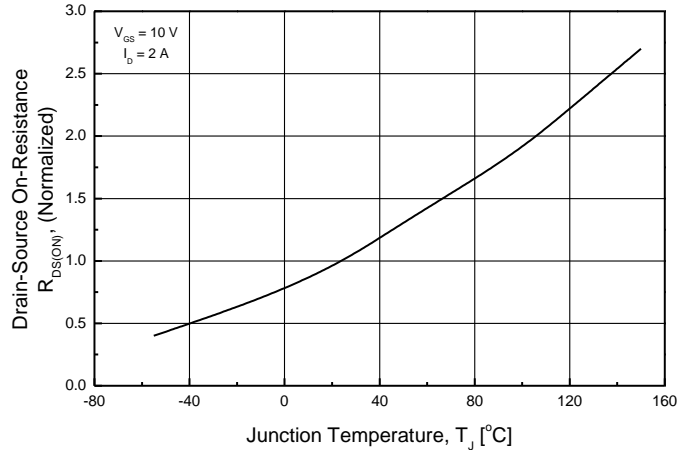
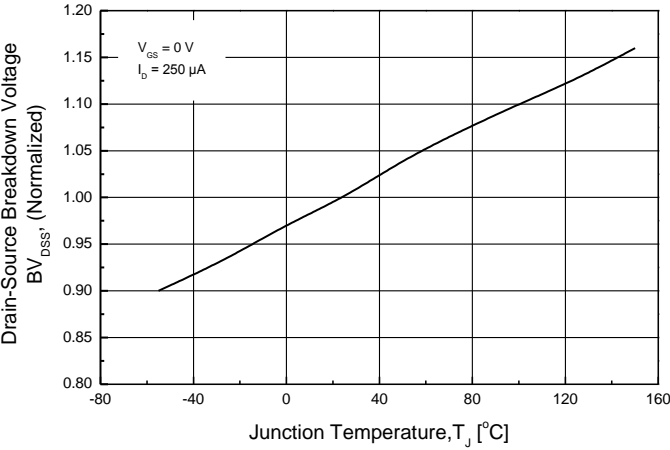

TMP4N80(G)

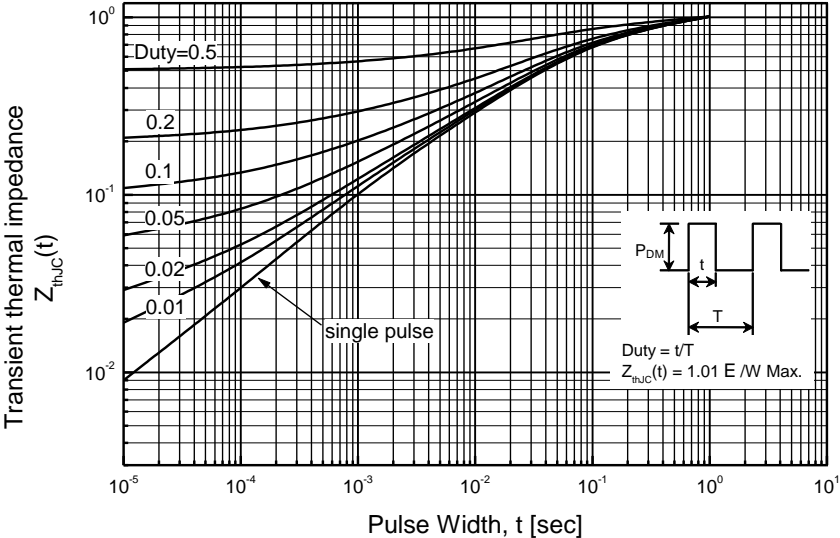

TMPF4N80(G)

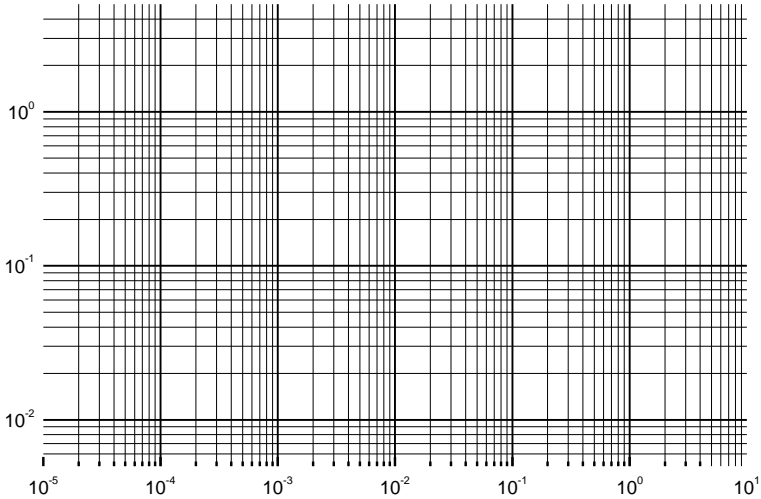

TO-220AB-3L MECHANICAL DATA

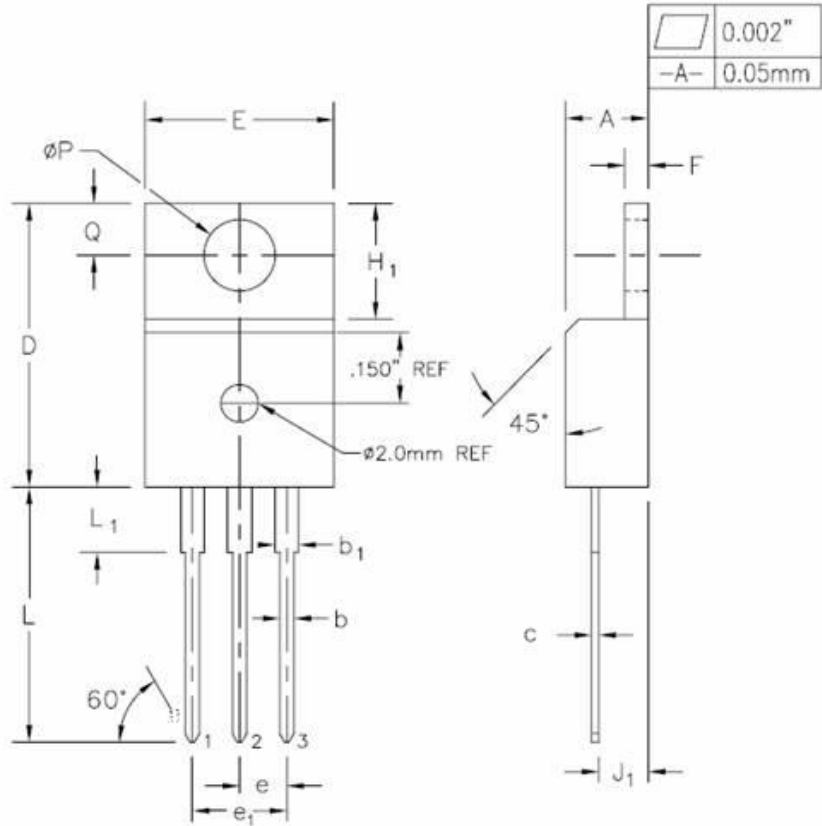

SYMBOL	INCHES		MILLIMETERS		NOTES
	MIN.	MAX.	MIN.	MAX.	
A	0.170	0.180	4.32	4.57	
b_1	0.028	0.036	0.71	0.91	
b	0.045	0.055	1.15	1.39	
c	0.014	0.021	0.36	0.53	
D	0.590	0.610	14.99	15.49	



TO-220F-3L MECHANICAL DATA

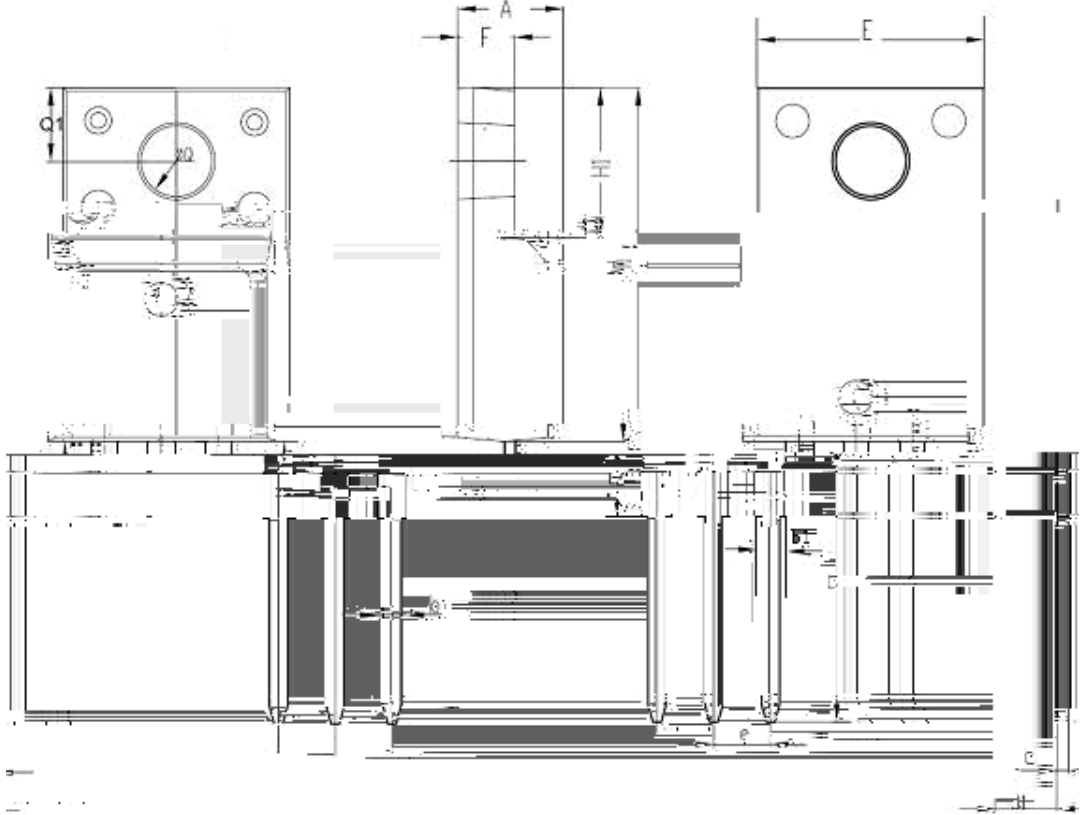

NC M	JODI F !		NJMJNF F !!		O F !
	NJO!	NB !	NJO!	NB !	
B!	1 289!!	1 2 5!!	5 64!!	5 4!!	!
!	1 139!!	1 147!!	1 82!!	1 2!!	!
D!	1 129!	1 135!	1 56!	1 71!	!
E!	1 728!!	1 744!!	26 78!!	27 18!!	!
F!	1 4 3!!	1 519!!	7!!	21 47!!	!
!	1 211!	!	3 65	!	!
I 2!	1 367!!	1 383!!	7 61!!	7 1!!	!
2!	1 212!!	1 228!!	3 67!!	3 7!!	!
M	1 614!!	1 62 !!	23 89!!	24 29!!	!
φQ!	1 228!!	1 244!!	3 9!!	4 49!!	!
2!	1 156!!	1 166!!	2 26!!	2 4 !!	!
M2!	1 225!	1 241!!	3 !!	4 4!!	!
2!	1 233!!	1 249!!	4 21!!	4 61!!	!
!	1 1 3!	1 219!	3 45!	3 85!	