

General Description

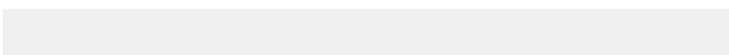

Absolute Maximum Ratings

| Parameter | Symbol | Value | Unit |
|-----------|--------|-------|------|
| | | | |
| | | | |
| | | | |
| | | | |
| | | | |
| | | | |
| | | | |
| | | | |
| | | | |
| | | | |
| | | | |
| | | | |
| | | | |
| | | | |

Thermal Characteristics

| Parameter | Symbol | Value | Unit |
|-----------|--------|-------|------|
| | | | |
| | | | |

Electrical Characteristics

| Parameter | Symbol | Min. | Typ. | Max. | Unit | Test condition |
|-----------|--------|------|------|------|------|----------------|
| | | | | | | |
| | | | | | | |
| | | | | | | |
| | | | | | | |
| | | | | | | |
| | | | | | | |
| | | | | | | |
| | | | | | | |
| | | | | | | |

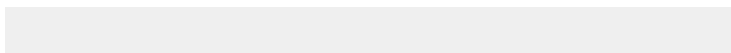

Dynamic Characteristics

| Parameter | Symbol | Min. | Typ. | Max. | Unit | Test condition |
|-----------|--------|------|------|------|------|----------------|
| | | | | | | |
| | | | | | | |
| | | | | | | |
| | | | | | | |
| | | | | | | |
| | | | | | | |
| | | | | | | |

Gate Charge Characteristics

| Parameter | Symbol | Min. | Typ. | Max. | Unit | Test condition |
|-----------|--------|------|------|------|------|----------------|
| | | | | | | |
| | | | | | | |
| | | | | | | |
| | | | | | | |

Body Diode Characteristics

| Parameter | Symbol | Min. | Typ. | Max. | Unit | Test condition |
|-----------|--------|------|------|------|------|----------------|
| | | | | | | |
| | | | | | | |
| | | | | | | |
| | | | | | | |

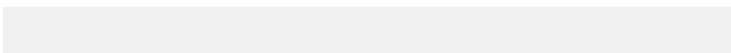
Note

Electrical Characteristics Diagrams

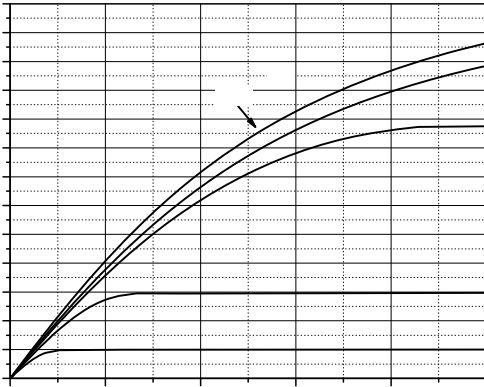

Figure 1. Typ. output characteristics

Figure 2. Typ. transfer characteristics

Figure 3. Typ. capacitances

Figure 4. Typ. gate charge

Figure 5. Drain-source breakdown voltage

Figure 6. Drain-source on-state resistance

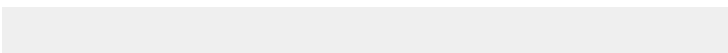

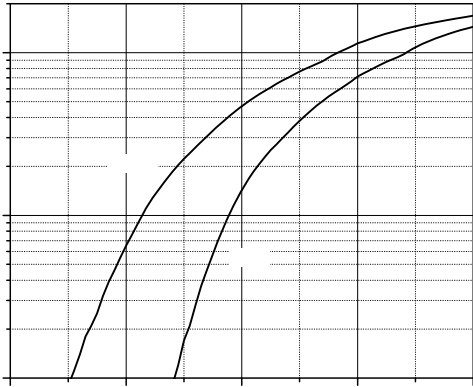

Figure 7. Forward characteristic of body diode

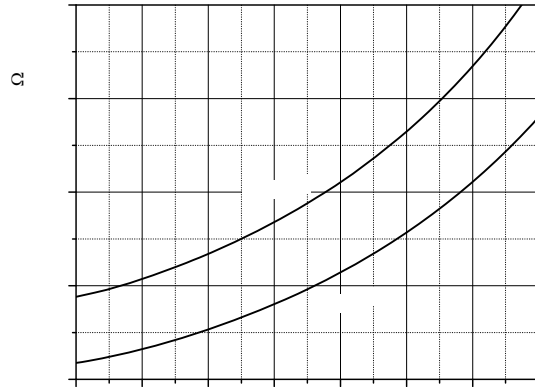

Figure 8. Drain-source on-state resistance

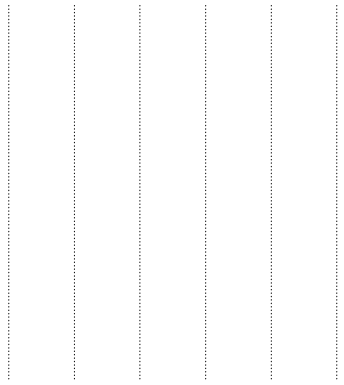

Figure 9. Drain current

Figure 10. Safe operation area $T_C=25\text{ }^\circ\text{C}$

Test circuits and waveforms

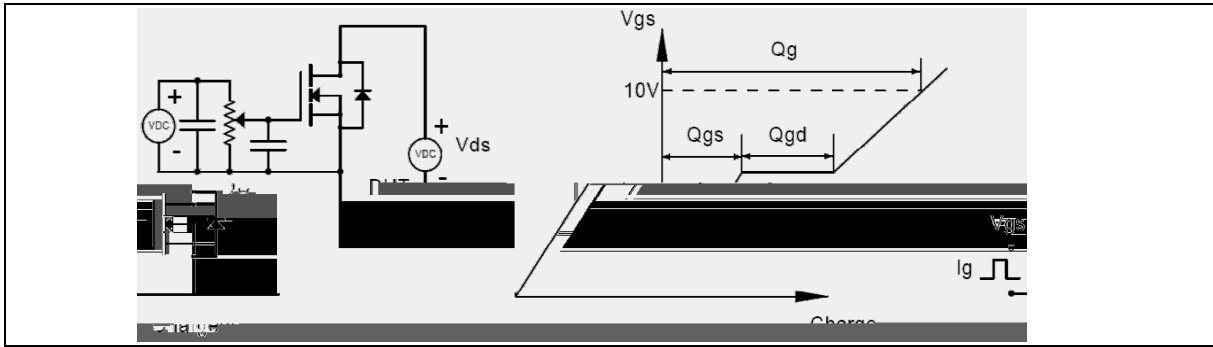

Figure 1. Gate charge test circuit & waveform

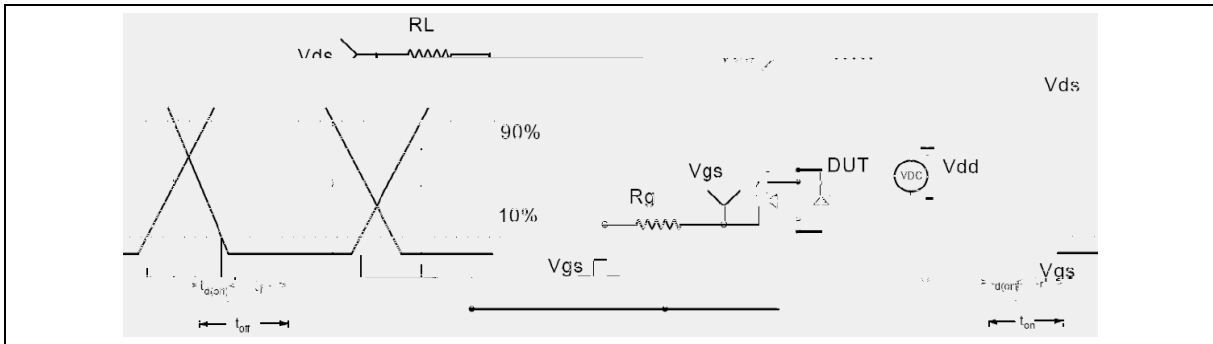

Figure 2. Switching time test circuit & waveforms

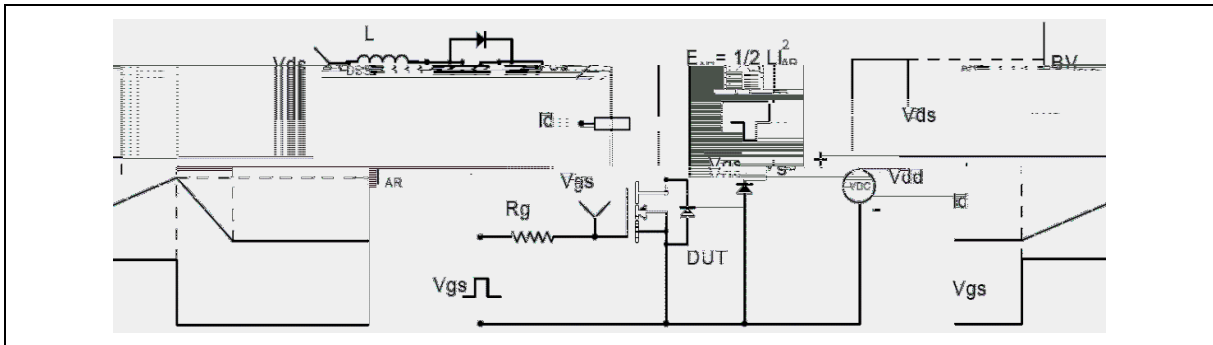

Figure 3. Unclamped inductive switching (UIS) test circuit & waveforms

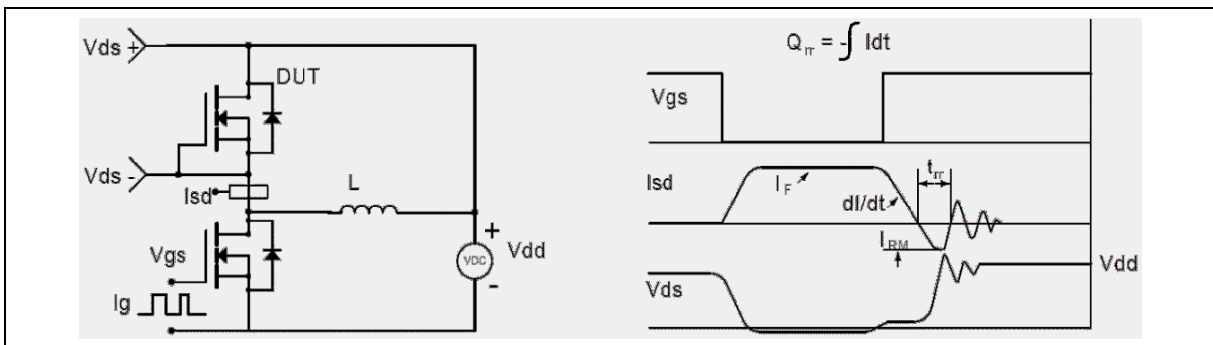
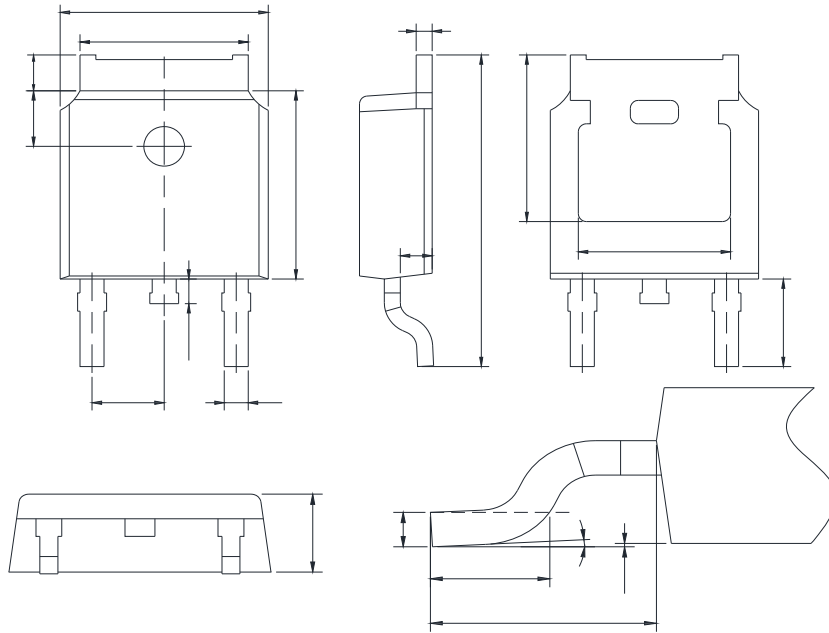

Figure 4. Diode reverse recovery test circuit & waveforms

Package Information



| | | | |
|--|--|--|--|
| | | | |
| | | | |
| | | | |
| | | | |
| | | | |
| | | | |
| | | | |
| | | | |
| | | | |
| | | | |
| | | | |
| | | | |
| | | | |
| | | | |
| | | | |
| | | | |
| | | | |
| | | | |
| | | | |
| | | | |
| | | | |

Package Information

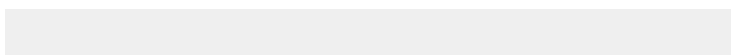
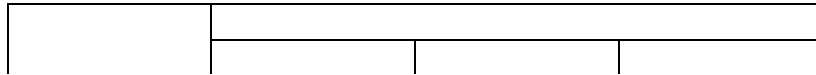

Ordering Information

| Package Type | Units/ Reel | Reels / Inner Box | Units/ Inner Box | Inner Box/ Carton Box | Units/ Carton Box |
|--------------|-------------|-------------------|------------------|-----------------------|-------------------|
| | | | | | |
| | | | | | |

Product Information

| Product | Package | Pb Free | RoHS | Halogen Free |
|---------|---------|---------|------|--------------|
| | | | | |

Legal Disclaimer

© Oriental Semiconductor Co.,Ltd. All Rights Reserved 

