

## General Description

The GreenMOS® high voltage MOSFET utilizes charge balance technology to achieve outstanding low on-resistance and lower gate charge. It is engineered to minimize conduction loss, provide superior switching performance and robust avalanche capability.

The GreenMOS® Z series is integrated with fast recovery diode (FRD) to minimize reverse recovery time. It is suitable for resonant switching topologies to reach higher efficiency, higher reliability and smaller form factor.

## Features

- Low  $R_{DS(ON)}$  & FOM
- Extremely low switching loss
- Excellent stability and uniformity
- Ultra-fast and robust body diode

## Applications

- PC power
- Telecom power
- Server power
- EV Charger
- Motor driver



## Key Performance Parameters

Parameter	Value	Unit
$V_{DS, min} @ T_{j(max)}$	650	V
$I_D, pulse$	240	A
$R_{DS(ON), max} @ V_{GS}=10V$	30	m
$Q_g$	186	nC

## Marking Information

Product Name	Package	Marking
OSG60R030HTZF	TO247	OSG60R030HTZ

## Package & Pin Information

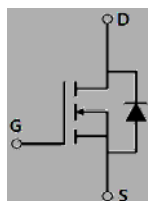

**Absolute Maximum Ratings** at  $T_j=25^\circ\text{C}$  unless otherwise noted

Parameter	Symbol	Value	Unit
Drain-source voltage	$V_{DS}$	600	V
Gate-source voltage	$V_{GS}$	$\pm 30$	V
Continuous drain current <sup>1)</sup> , $T_C=25^\circ\text{C}$	$I_D$	80	A
Continuous drain current <sup>1)</sup> , $T_C=100^\circ\text{C}$		50	
Pulsed drain current <sup>2)</sup> , $T_C=25^\circ\text{C}$	$I_{D, pulse}$	240	A
Continuous diode forward current <sup>1)</sup> , $T_C=25^\circ\text{C}$	$I_S$	80	A
Diode pulsed current <sup>2)</sup> , $T_C=25^\circ\text{C}$	$I_{S, pulse}$	240	A
Power dissipation <sup>3)</sup> , $T_C=25^\circ\text{C}$	$P_D$	450	W
Single pulsed avalanche energy <sup>5)</sup>	$E_{AS}$	2190	mJ
MOSFET dv/dt ruggedness, $V_{DS}=0\dots 480\text{ V}$	dv/dt	50	V/ns
Reverse diode dv/dt, $V_{DS}=0\dots 480\text{ V}$ , $I_{SD} = I_D$	dv/dt	50	V/ns
Operation and storage temperature	$T_{stg}, T_j$	-55 to 150	$^\circ\text{C}$

**Thermal Characteristics**

Parameter	Symbol	Value	Unit
Thermal resistance, junction-case	$R_{JC}$	0.28	$^\circ\text{C/W}$
Thermal resistance, junction-ambient <sup>4)</sup>	$R_{JA}$	62	$^\circ\text{C/W}$

**Electrical Characteristics** at  $T_j=25^\circ\text{C}$  unless otherwise specified

Parameter	Symbol	Min.	Typ.	Max.	Unit	Test condition
Drain-source breakdown voltage	$BV_{DSS}$	600			V	$V_{GS}=0\text{ V}$ , $I_D=1\text{ mA}$
		650				$V_{GS}=0\text{ V}$ , $I_D=1\text{ mA}$ , $T_j=150^\circ\text{C}$
Gate threshold voltage	$V_{GS(th)}$	3.0		4.5	V	$V_{DS}=V_{GS}$ , $I_D=2\text{ mA}$ ,
Drain-source on-state resistance	$R_{DS(ON)}$		0.026	0.03		$V_{GS}=10\text{ V}$ , $I_D=40\text{ A}$
			0.064			$V_{GS}=10\text{ V}$ , $I_D=40\text{ A}$ , $T_j=150^\circ\text{C}$
Gate-source leakage current	$I_{GSS}$			100	nA	$V_{GS}=30\text{ V}$
				-100		$V_{GS}=-30\text{ V}$
Drain-source leakage current	$I_{DSS}$			10	$\mu\text{A}$	$V_{DS}=600\text{ V}$ , $V_{GS}=0\text{ V}$
Gate resistance	$R_G$		2.2			$f=1\text{ MHz}$ , Open drain

### Dynamic Characteristics

Parameter	Symbol	Min.	Typ.	Max.	Unit	Test condition
Input capacitance	$C_{iss}$		8300		pF	$V_{GS}=0\text{ V}$ , $V_{DS}=50\text{ V}$ , $f=100\text{ KHz}$
Output capacitance	$C_{oss}$		555		pF	
Reverse transfer capacitance	$C_{rss}$		15		pF	
Turn-on delay time	$t_{d(on)}$		54.5		ns	$V_{GS}=10\text{ V}$ , $V_{DS}=400\text{ V}$ , $R_G=2\text{ }\Omega$ , $I_D=40\text{ A}$
Rise time	$t_r$		91.5		ns	
Turn-off delay time	$t_{d(off)}$		113.6		ns	
Fall time	$t_f$		6		ns	

### Gate Charge Characteristics

Parameter	Symbol	Min.	Typ.	Max.	Unit	Test condition
Total gate charge	$Q_g$		186		nC	$V_{GS}=10\text{ V}$ , $V_{DS}=400\text{ V}$ , $I_D=40\text{ A}$
Gate-source charge	$Q_{gs}$		48.6		nC	
Gate-drain charge	$Q_{gd}$		59.6		nC	
Gate plateau voltage	$V_{plateau}$		6.9		V	

### Body Diode Characteristics

Parameter	Symbol	Min.	Typ.	Max.	Unit	Test condition
Diode forward voltage	$V_{SD}$			1.4	V	$I_S=80\text{ A}$ , $V_{GS}=0\text{ V}$
Reverse recovery time	$t_{rr}$		200		ns	$I_S=40\text{ A}$ , $di/dt=100\text{ A}/\mu\text{s}$
Reverse recovery charge	$Q_{rr}$		1.5		$\mu\text{C}$	
Peak reverse recovery current	$I_{rrm}$		13.3		A	

### Note

- 1) Calculated continuous current based on maximum allowable junction temperature.
- 2) Repetitive rating; pulse width limited by max. junction temperature.
- 3)  $P_d$  is based on max. junction temperature, using junction-case thermal resistance.
- 4) The value of  $R_{JA}$  is measured with the device mounted on 1 in 2 FR-4 board with 2oz. Copper, in a still air environment with  $T_a=25\text{ }^\circ\text{C}$ .
- 5)  $V_{DD}=100\text{ V}$ ,  $V_{GS}=10\text{ V}$ ,  $L=80\text{ mH}$ , starting  $T_j=25\text{ }^\circ\text{C}$ .

**Electrical Characteristics Diagrams**

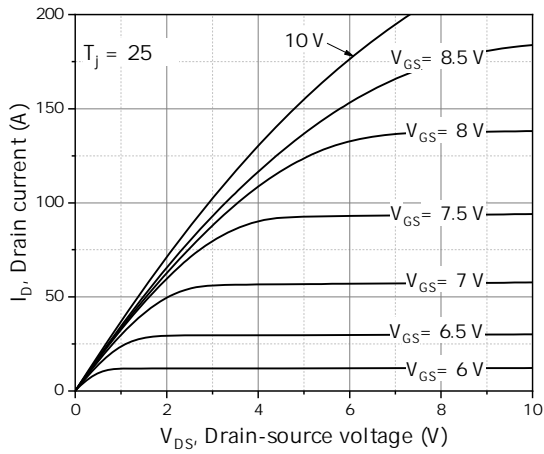

**Figure 1. Typ. output characteristics**

**Figure 2. Typ. transfer characteristics**

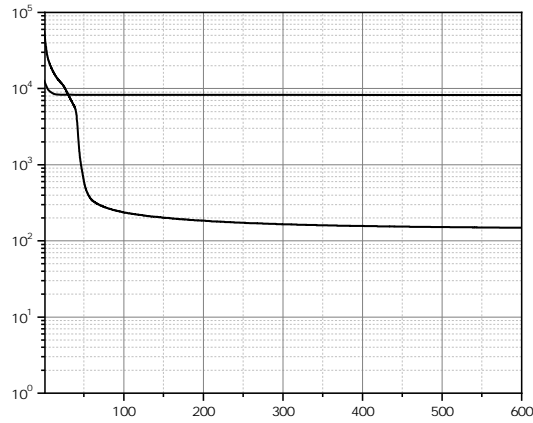

**Figure 3. Typ. capacitances**

**Figure 4. Typ. gate charge**

**Figure 5. Drain-source breakdown voltage**

**Figure 6. Drain-source on-state resistance**

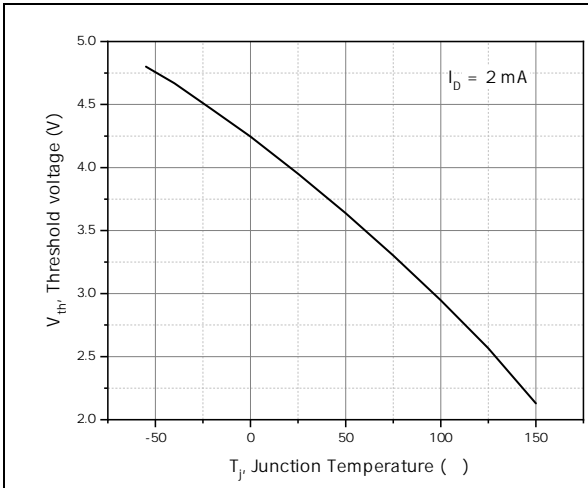

Figure 7. Threshold voltage

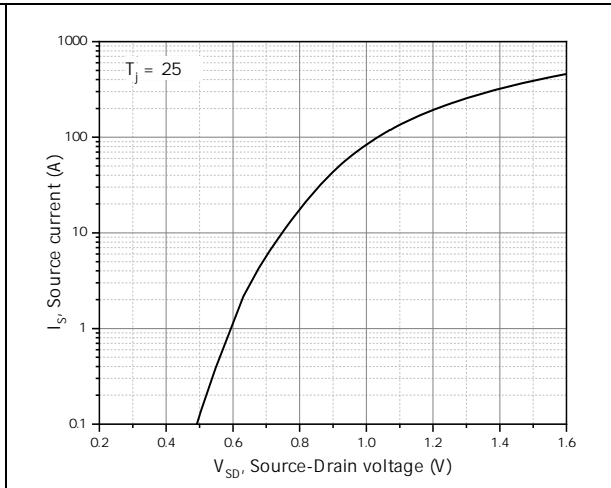

Figure 8. Forward characteristic of body diode

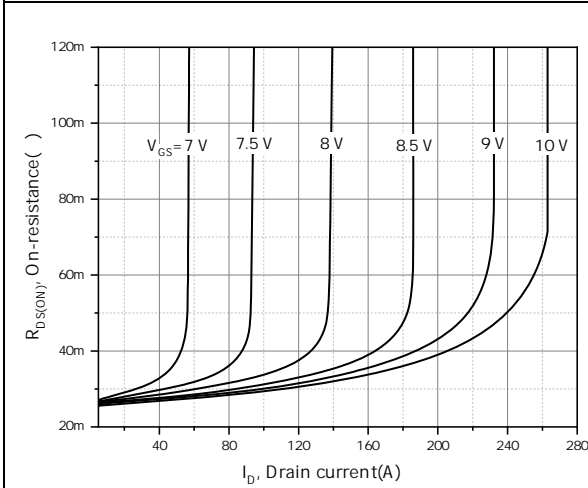

Figure 9. Drain-source on-state resistance

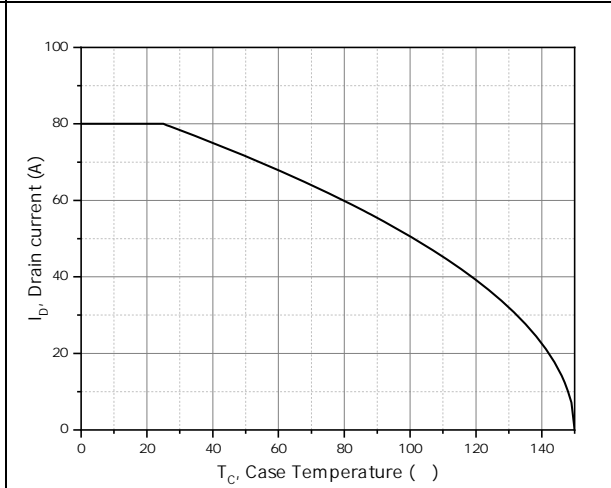

Figure 10. Drain current

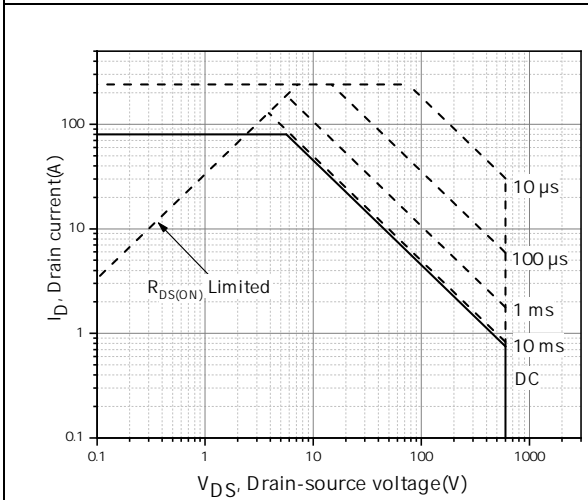

Figure 11. Safe operation area for TC=25

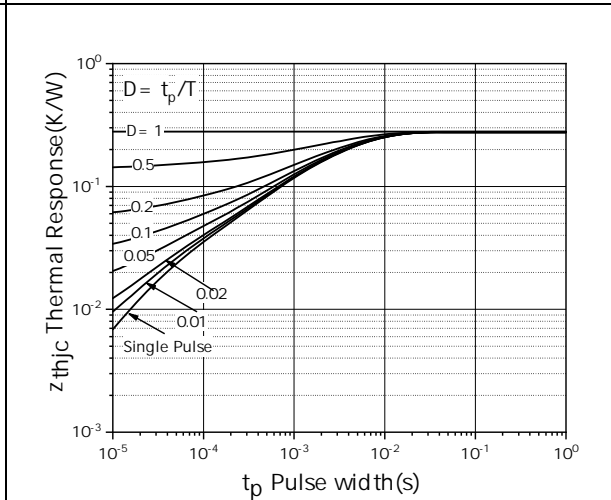

Figure 12. Max. transient thermal impedance

Test circuits and waveforms

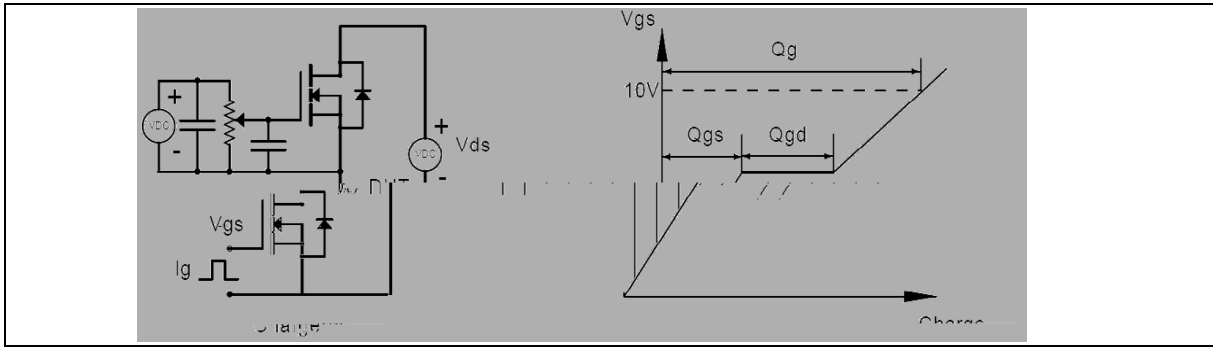

Figure 1. Gate charge test circuit & waveform

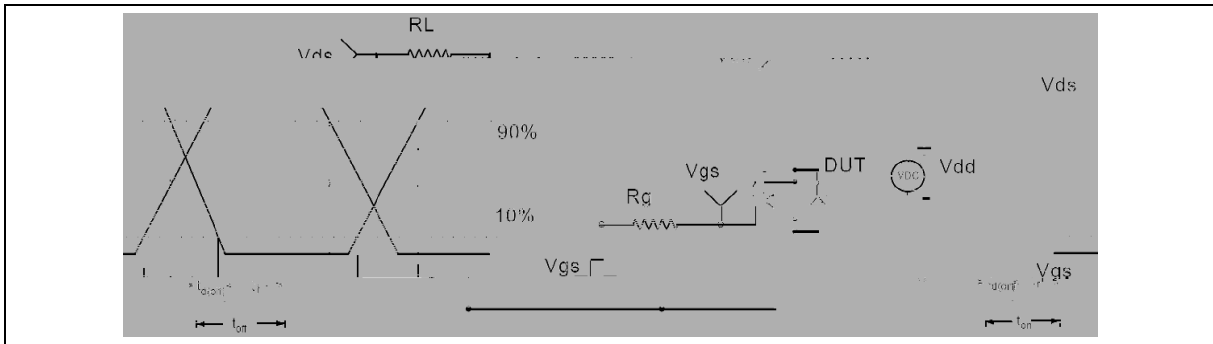

Figure 2. Switching time test circuit & waveforms

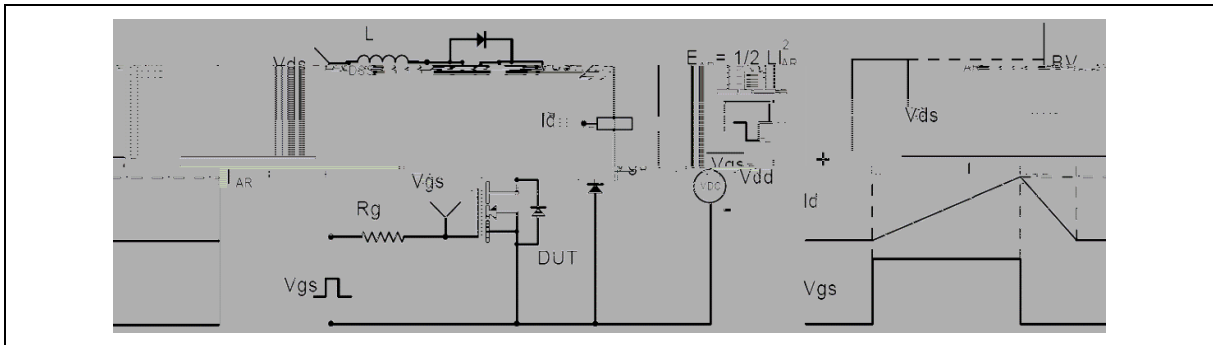

Figure 3. Unclamped inductive switching (UIS) test circuit & waveforms

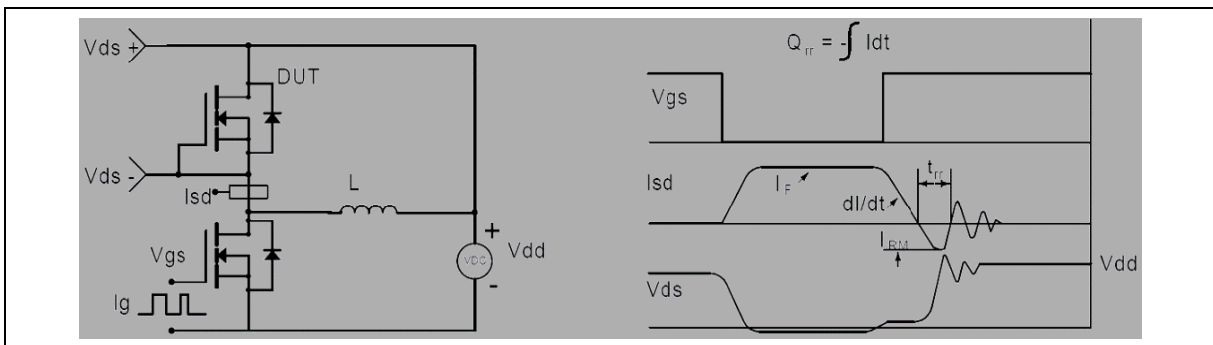
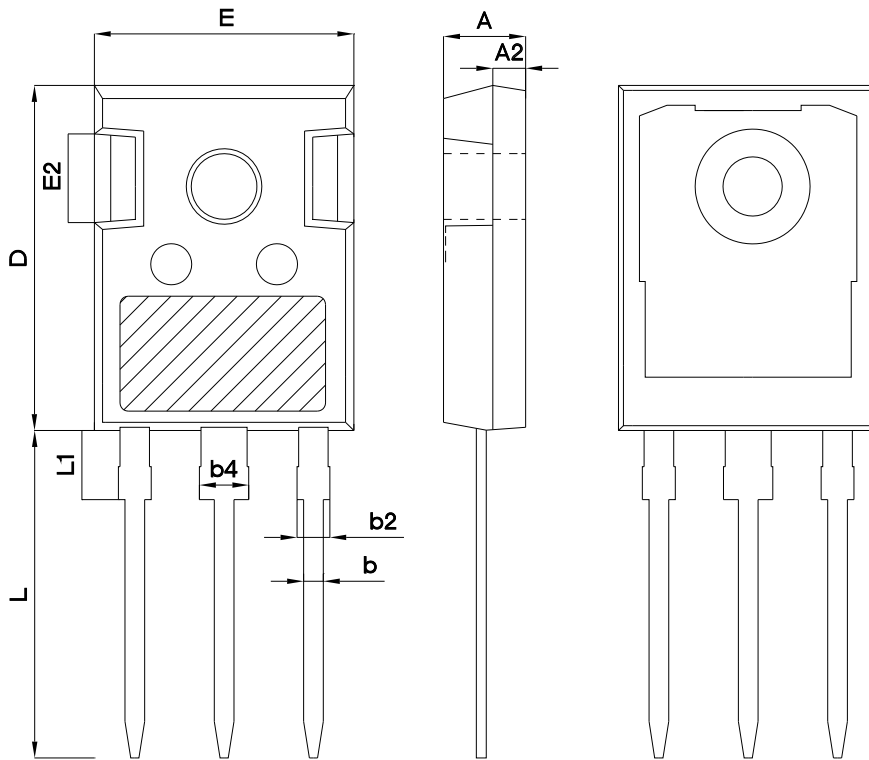

Figure 4. Diode reverse recovery test circuit & waveforms

**Package Information**

Symbol	mm		
	Min	Nom	Max
A	4.80	5.00	5.20
A1	2.21	2.41	2.59
A2	1.85	2.00	2.15
b	1.11	1.21	1.36
b2	1.91	2.01	2.21
b4	2.91	3.01	3.21
c	0.51	0.61	0.75
D	20.80	21.00	21.30
D1	16.25	16.55	16.85
E	15.50	15.80	16.10
E1	13.00	13.30	13.60
E2	4.80	5.00	5.20
E3	2.30	2.50	2.70
e	5.44 BSC		
L	19.82	19.92	20.22
L1	-	-	4.30
P	3.40	3.60	3.80
P1	-	-	7.30
S	6.15 BSC		

Version 1; TO247-C package outline dimension

### Ordering Information

Package Type	Units/ Tube	Tubes/ Inner Box	Units/ Inner Box	Inner Boxes/ Carton Box	Units/ Carton Box
TO247-C	30	11	330	6	1980

### Product Information

Product	Package	Pb Free	RoHS	Halogen Free
OSG60R030HTZF	TO247	yes	yes	yes

### Legal Disclaimer

The information given in this document shall in no event be regarded as a guarantee of conditions or characteristics. With respect to any examples or hints given herein, any typical values stated herein and/or any information regarding the application of the device, Oriental Semiconductor hereby disclaims any and all warranties and liabilities of any kind, including without limitation, warranties of non-infringement of intellectual property rights of any third party.

For further information on technology, delivery terms and conditions and prices, please contact the Oriental Semiconductor sales representatives ([www.orientalsemi.com](http://www.orientalsemi.com)).

© Oriental Semiconductor Co.,Ltd. All Rights Reserved 

