

## General Description

### Features

- 
- 
- 

 GreenMOS<sup>®</sup>

 RoHS  
compliant

### Applications

- 
- 
- 
- 
- 
- 
- 

### Key Performance Parameters

Parameter	Value	Unit

### Marking Information

Product Name	Package	Marking

### Package & Pin Information

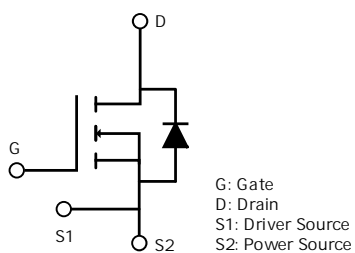



**Dynamic Characteristics**

Parameter	Symbol	Min.	Typ.	Max.	Unit	Test condition

**Gate Charge Characteristics**

Parameter	Symbol	Min.	Typ.	Max.	Unit	Test condition

**Body Diode Characteristics**

Parameter	Symbol	Min.	Typ.	Max.	Unit	Test condition

**Note**

**Electrical Characteristics Diagrams**

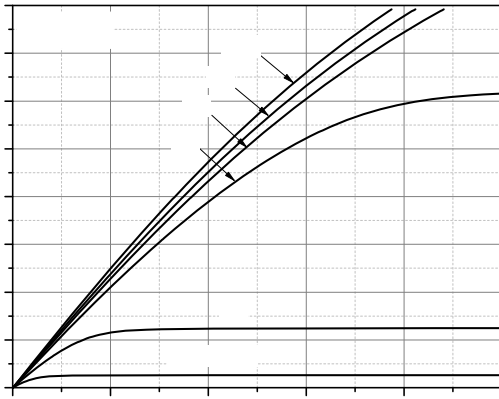

**Figure 1. Typ. output characteristics**

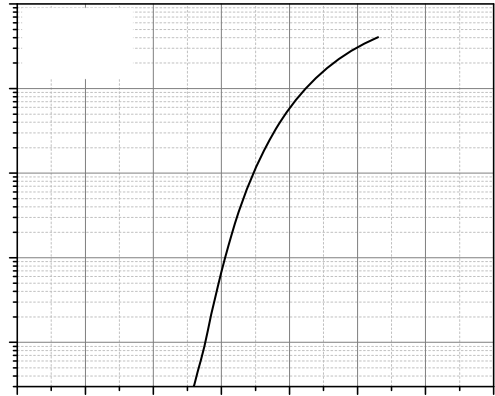

**Figure 2. Typ. transfer characteristics**



**Figure 3. Typ. capacitances**

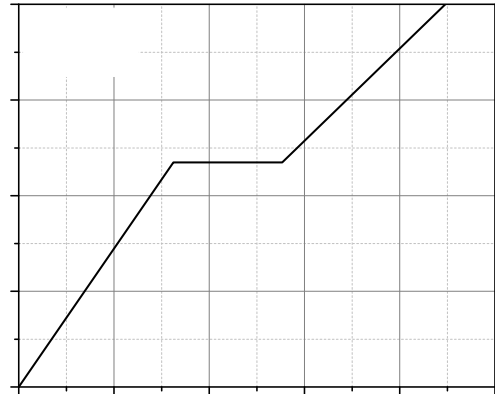

**Figure 4. Typ. gate charge**

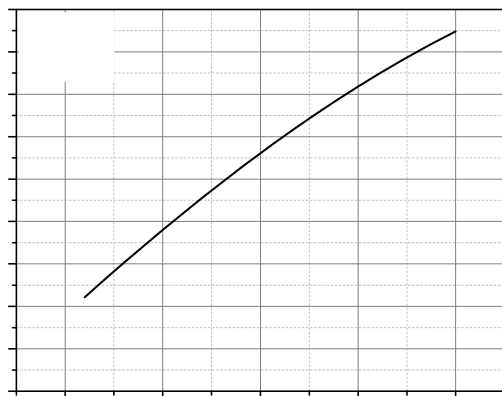

**Figure 5. Drain-source breakdown voltage**

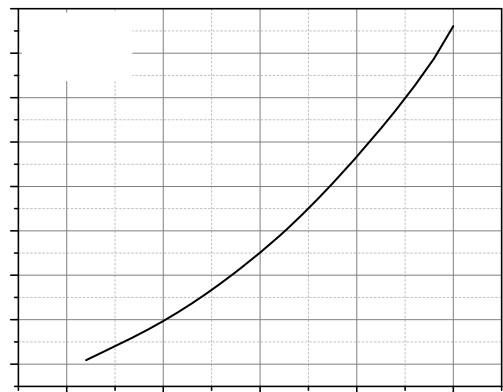

**Figure 6. Drain-source on-state resistance**

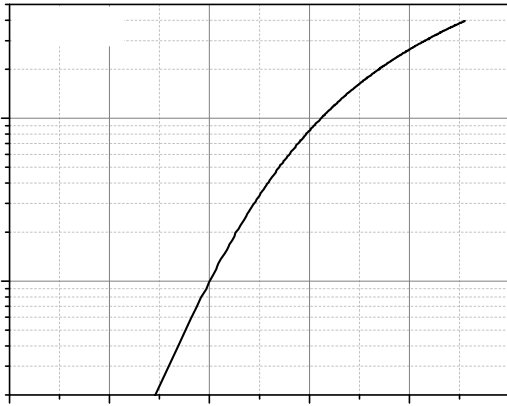

**Figure 7. Forward characteristic of body diode**

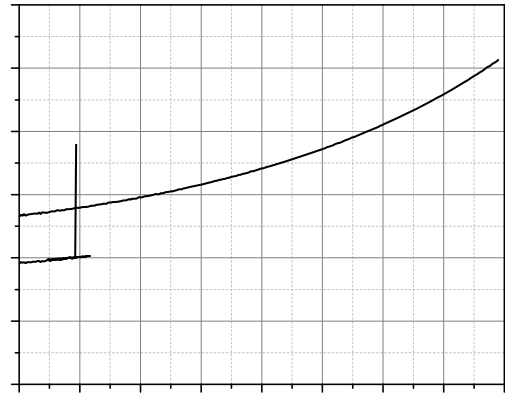
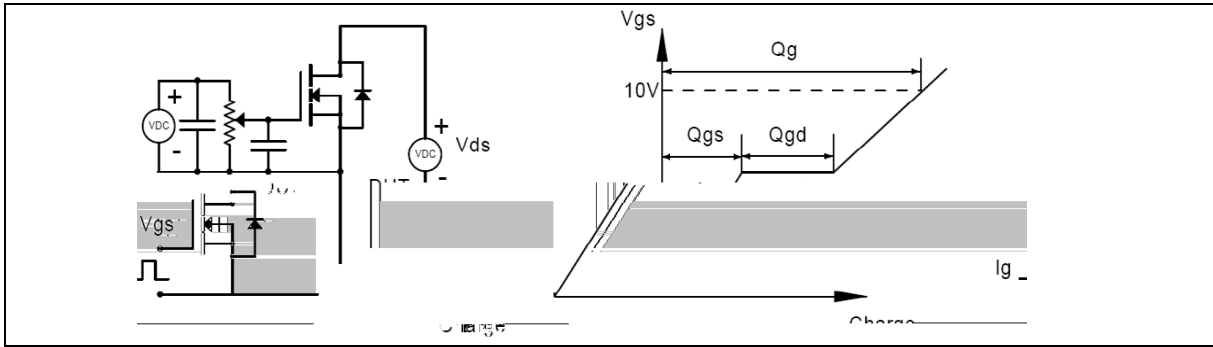

**Figure 8. Drain-source on-state resistance**

**Figure 9. Drain current**

**Figure 10. Safe operation area  $T_C=25\text{ }^\circ\text{C}$**

**Test circuits and waveforms**



**Figure 1. Gate charge test circuit & waveform**

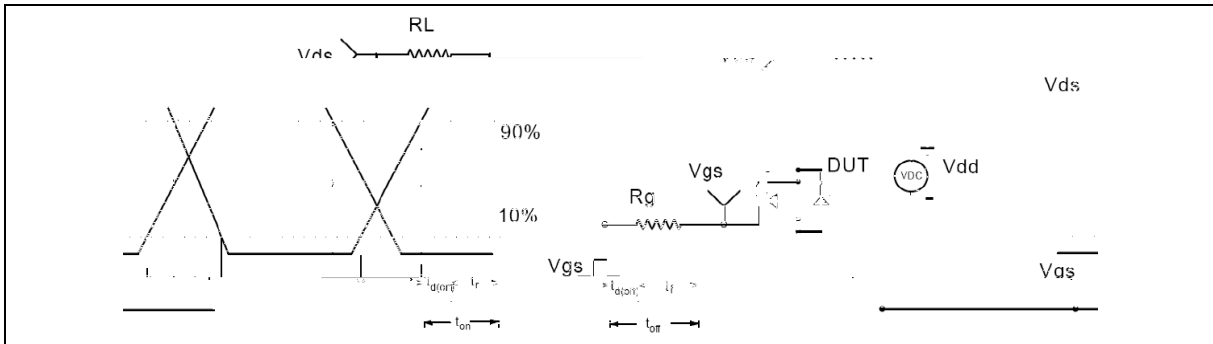

**Figure 2. Switching time test circuit & waveforms**

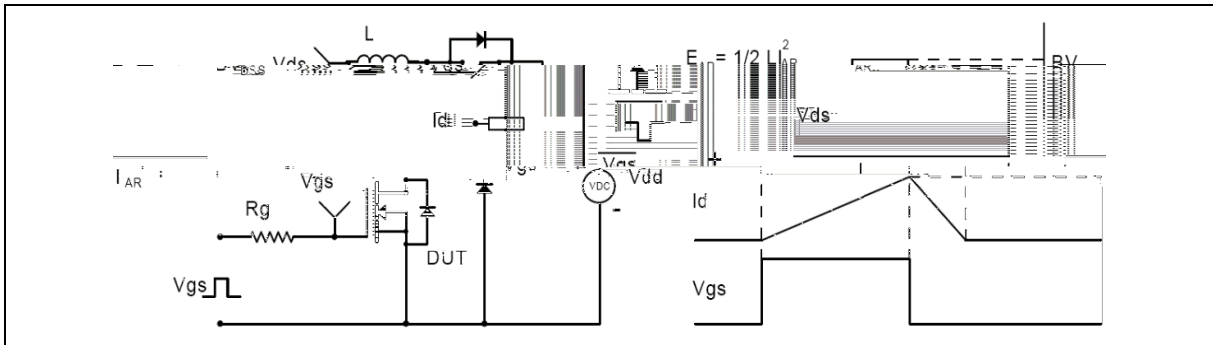
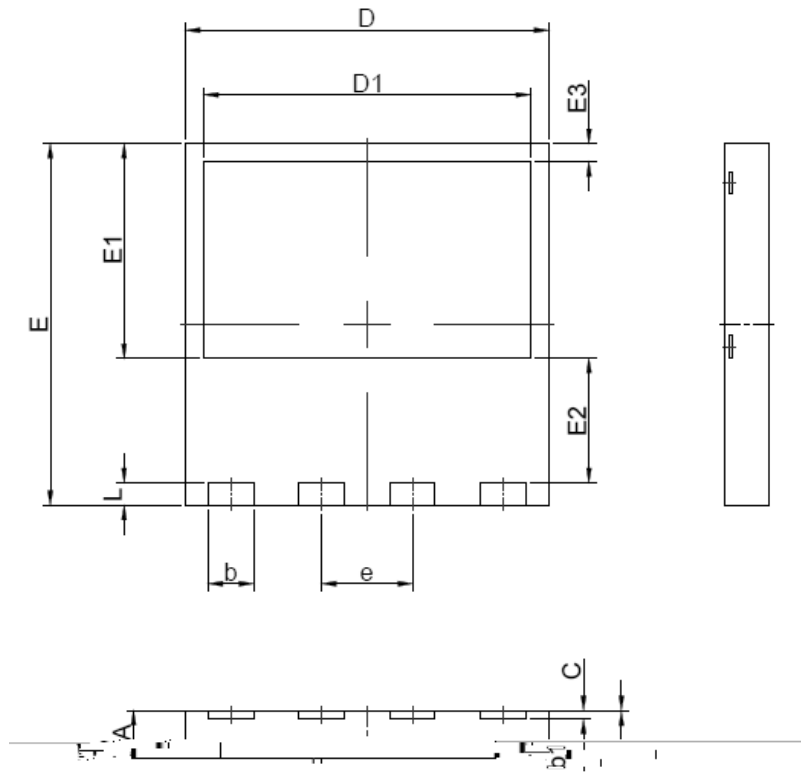

**Figure 3. Unclamped inductive switching (UIS) test circuit & waveforms**



**Figure 4. Diode reverse recovery test circuit & waveforms**

Package Information



**Ordering Information**

Package Type	Units/ Reel	Reels/ Inner Box	Units/ Inner Box	Inner Boxes/ Carton Box	Units/ Carton Box

**Product Information**

Product	Package	Pb Free	RoHS	Halogen Free

**Legal Disclaimer**

---

© Oriental Semiconductor Co.,Ltd. All Rights Reserved 