

**D-PAK**

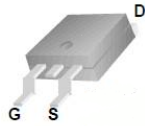

Device	Package	Marking	Remark
TMD8N50Z/TMU8N50Z	D-PAK/I-PAK	TMD8N50Z/TMU8N50Z	RoHS
TMD8N50ZG/TMU8N50ZG	D-PAK/I-PAK	TMD8N50ZG/TMU8N50ZG	Halogen Free

### Absolute Maximum Ratings

\* Limited only by maximum junction temperature

### Thermal Characteristics

**Electrical Characteristics :  $T_C=25$  , unless otherwise noted**

Parameter	Symbol	Test condition	Min	Typ	Max	Units
<b>OFF</b>						
Drain-Source Breakdown Voltage	$BV_{DSS}$	$V_{GS} = 0\text{ V}, I_D = 250\ \mu\text{A}$	500	--	--	V
Zero Gate Voltage Drain Current	$I_{DSS}$	$V_{DS} = 500\text{ V}, V_{GS} = 0\text{ V}$	--	--	1	$\mu\text{A}$
		$V_{DS} = 400\text{ V}, T_C = 125^\circ\text{C}$	--	--	10	$\mu\text{A}$
Forward Gate-Source Leakage Current	$I_{GSSF}$	$V_{GS} = 30\text{ V}, V_{DS} = 0\text{ V}$	--	--	100	$\mu\text{A}$
Reverse Gate-Source Leakage Current	$I_{GSSR}$	$V_{GS} = -30\text{ V}, V_{DS} = 0\text{ V}$	--	--	-100	$\mu\text{A}$

**ON**

Gate Threshold Voltage	$V_{GS(th)}$	$V_{DS} = V_{GS}, I_D = 250\ \mu\text{A}$	3	--	5	V
Drain-Source On-Resistance	$R_{DS(on)}$	$V_{GS} = 10\text{ V}, I_D = 4.0\text{A}$	--	0.72	0.85	$\Omega$
Forward Transconductance <sup>(Note 4)</sup>	$g_{FS}$	$V_{DS} = 30\text{ V}, I_D = 4.0\text{A}$	--	10	--	S

**DYNAMIC**

Input Capacitance	$C_{iss}$	$V_{DS} = 25\text{ V}, V_{GS} = 0\text{ V},$ $f = 1.0\text{ MHz}$	--	937	--	pF
Output Capacitance	$C_{oss}$		--	132	--	pF
Reverse Transfer Capacitance	$C_{rss}$		--	19	--	pF

**SWITCHING**

Turn-On Delay Time <sup>(Note 4,5)</sup>	$t_{d(on)}$	$V_{DD} = 250\text{ V}, I_D = 8.0\text{A},$ $R_G = 25$	--	28	--	ns
Turn-On Rise Time <sup>(Note 4,5)</sup>	$t_r$		--	33	--	ns
Turn-Off Delay Time <sup>(Note 4,5)</sup>	$t_{d(off)}$		--	81	--	ns
Turn-Off Fall Time <sup>(Note 4,5)</sup>	$t_f$		--	24	--	ns
Total Gate Charge <sup>(Note 4,5)</sup>	$Q_g$	$V_{DS} = 400\text{V}, I_D = 8.0\text{A},$ $V_{GS} = 10\text{ V}$	--	21	--	nC
Gate-Source Charge <sup>(Note 4,5)</sup>	$Q_{gs}$		--	4.5	--	nC
Gate-Drain Charge <sup>(Note 4,5)</sup>	$Q_{gd}$		--	10	--	nC

**SOURCE DRAIN DIODE**

Maximum Continuous Drain-Source Diode Forward Current	$I_S$	----	--	--	8	A
Maximum Pulsed Drain-Source Diode Forward Current	$I_{SM}$	----	--	--	32	A
Drain-Source Diode Forward Voltage	$V_{SD}$	$V_{GS} = 0\text{ V}, I_S = 8.0\text{ A}$	--	--	1.5	V
Reverse Recovery Time <sup>(Note 4)</sup>	$t_{rr}$	$V_{GS} = 0\text{ V}, I_S = 8.0\text{ A}$	--	315	--	ns
Reverse Recovery Charge <sup>(Note 4)</sup>	$Q_{rr}$	$di_F / dt = 100\text{ A}/\mu\text{s}$	--	2.2	--	$\mu\text{C}$

Note :

1. Repeated rating : Pulse width limited by safe operating area
2.  $L=15.6\text{mH}, I_{AS} = 8\text{A}, V_{DD} = 50\text{V}, R_G = 25$  , Starting  $T_J = 25$
3.  $I_{SD} = 8.0\text{A}, di/dt = \mu\text{s}, V_{DD} = V_{DS}$ , Starting  $T_J = 25$
5. Essentially Independent of Operating Temperature Typical Characteristics

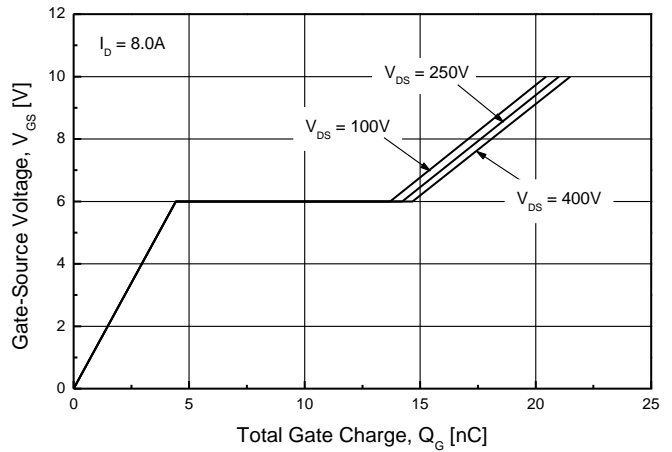
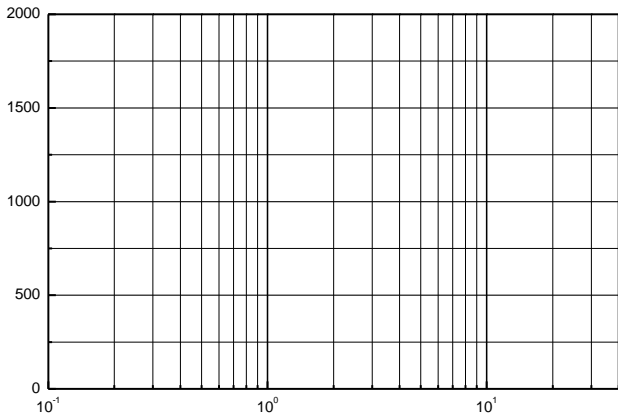
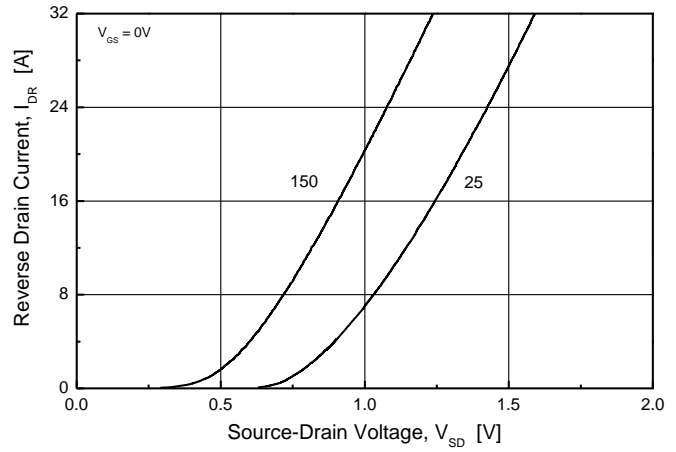
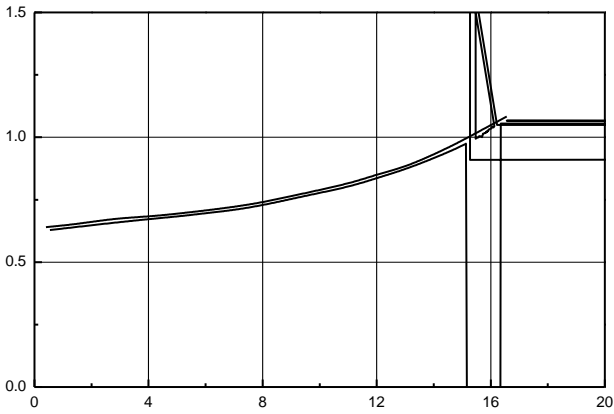
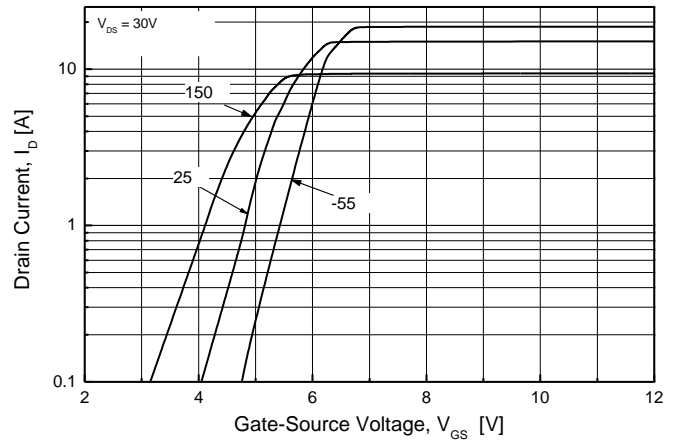
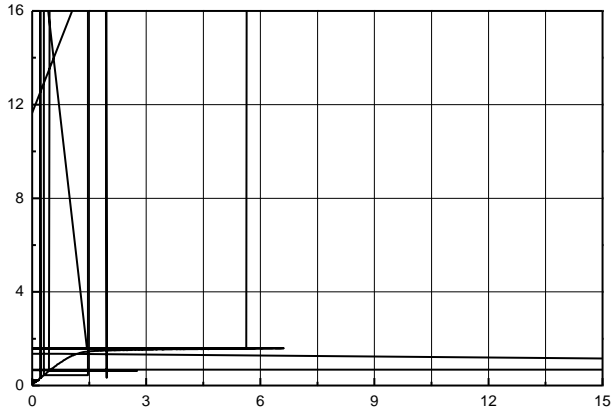

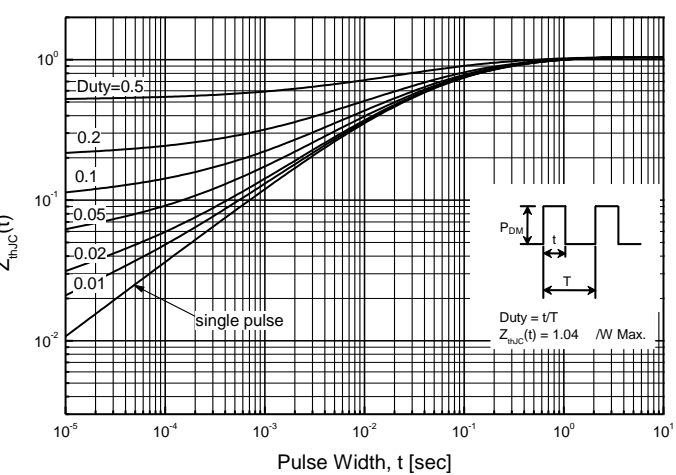
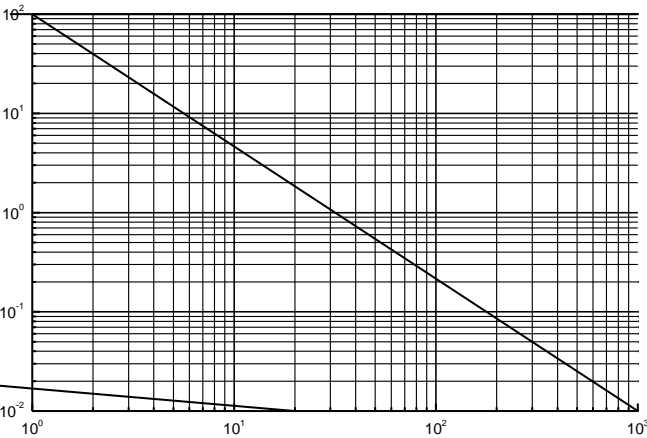
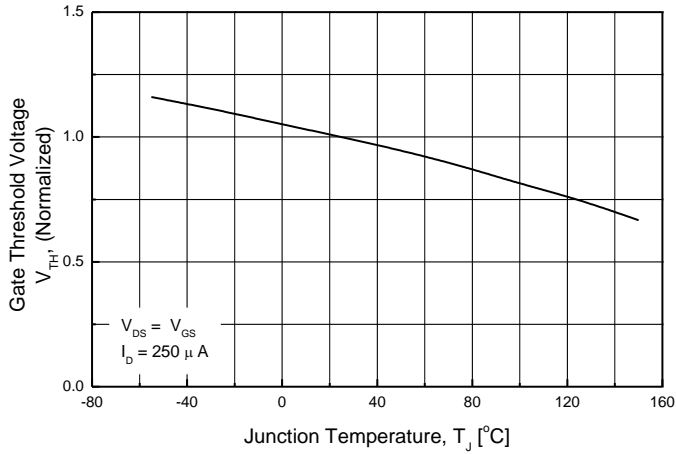
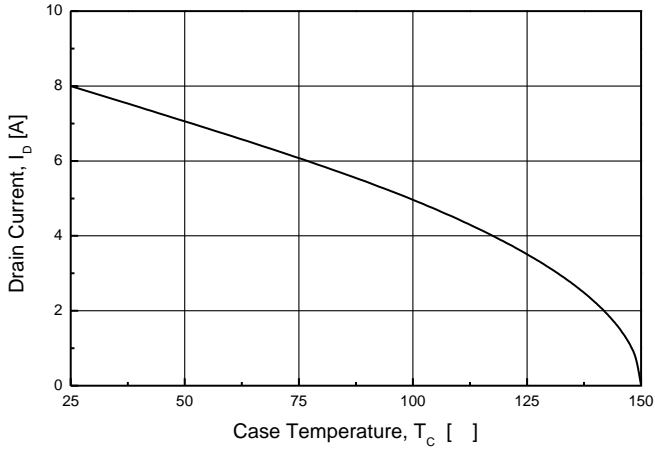
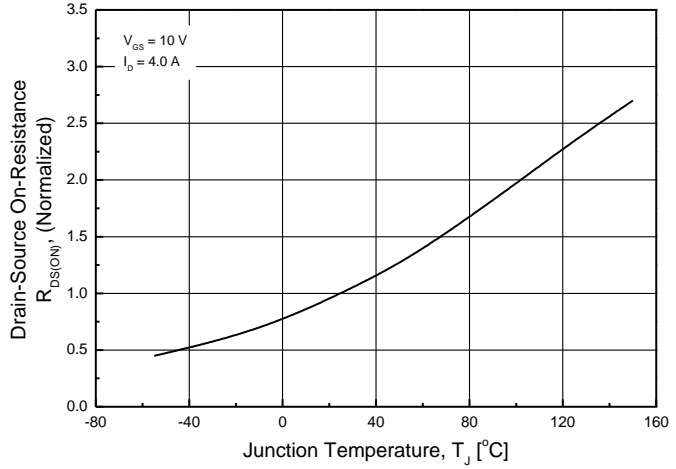
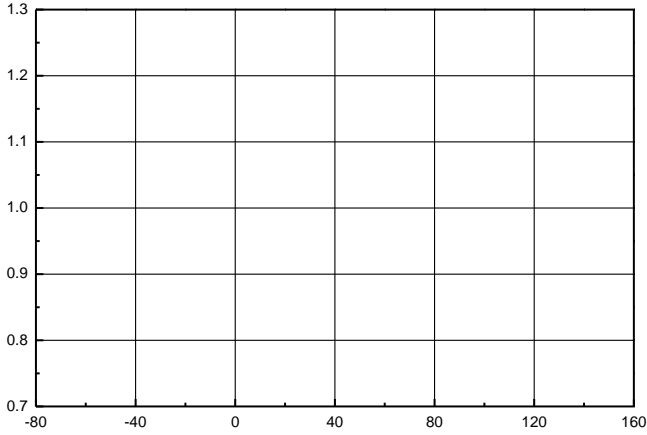

**TO-252 (D-PAK) MECHANICAL DATA**

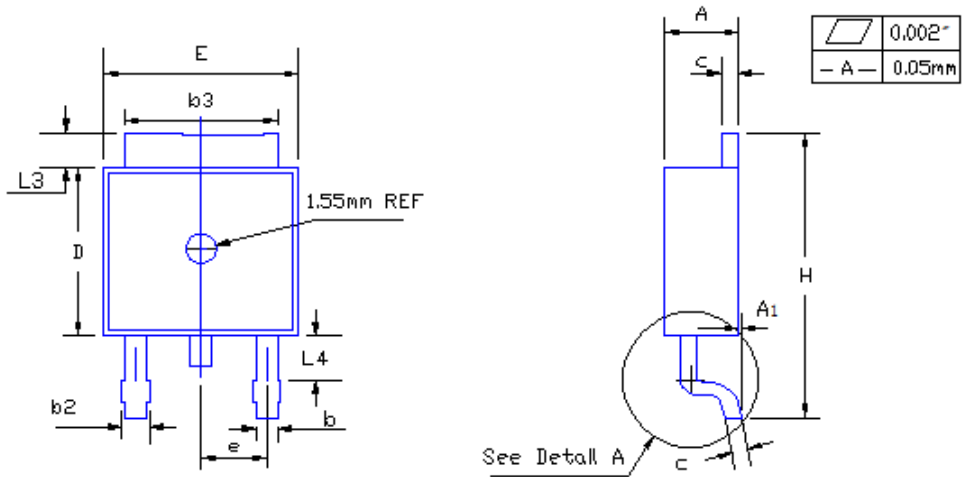

SYMBOL	MILLIMETERS	
	MIN	MAX
A	2.19	2.38
A1	—	0.13
b	0.64	0.89
b2	0.84	1.14
b3	5.21	5.46
c	0.46	0.61
D	5.97	6.22
D1	5.21	—
E	6.35	6.73
E1	4.83	—
e	2.29BSC	
H	9.65	10.41
L	1.40	1.78
L2	0.51BSC	
L3	0.89	1.27
L4	0.64	1.01
Ø	0	8

**TO-251 (I-PAK) MECHANICAL DATA**



SYMBOL	MILLIMETERS	
	MIN	MAX
A	2.19	2.38
A1	1.04	1.23
b	0.64	0.89
b1	0.84	1.14
b2	5.23	5.48
c	0.46	0.61
D	5.91	6.28
E	6.21	6.59
e	2.28 TYP	
L	8.89	9.65
L2	0.89	1.27