

Features

- Low gate charge
- 100% avalanche tested
- Improved dv/dt capability
- RoHS compliant
- Halogen free package
- JEDEC Qualification

BV _{DSS}		

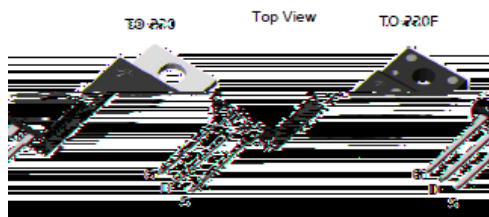

Device	Package	Marking	Remark
TMP20N50A / TMPF20N50A	TO-220 / TO-220F	TMP20N50A / TMPF20N50A	RoHS
TMP20N50AG / TMPF20N50AG	TO-220 / TO-220F	TMP20N50AG / TMPF20N50AG	Halogen Free

Absolute Maximum Ratings

Parameter	Symbol	TMP20N50A(G)	TMPF20N50A(G)	Unit	
Drain-Source Voltage	V _{DSS}	500		V	
Gate-Source Voltage	V _{GS}	30		V	
Continuous Drain Current	I _D	T _C = 25	18	18 *	A
		T _C = 100	12.4	12.4 *	A
Pulsed Drain Current (Note 1)	I _{DM}	72	72 *	A	
Single Pulse Avalanche Energy (Note 2)	E _{AS}	705		mJ	
Repetitive Avalanche Current (Note 1)	I _{AR}	18		A	
Repetitive Avalanche Energy (Note 1)	E _{AR}	29		mJ	
Power Dissipation	P _D	T _C = 25	290	48	W
		Derate above 25	2.32	0.38	W/
Peak Diode Recovery dv/dt (Note 3)	dv/dt	4.5		V/ns	
Operating Junction and Storage Temperature Range	T _J , T _{STG}	-55~150			
Maximum lead temperature for soldering purposes,	T _L	300			

* Limited only by maximum junction temperature

Thermal Characteristics

Parameter	Symbol	TMP20N50A(G)	TMPF20N50A(G)	Unit
Maximum Thermal resistance, Junction-to-Case	R _{θJC}	0.43	2.6	/W
Maximum Thermal resistance, Junction-to-Ambient	R _{θJA}	62.5	62.5	/W

Electrical Characteristics : $T_C=25$, unless otherwise noted

Parameter	Symbol	Test condition	Min	Typ	Max	Units
OFF						
Drain-Source Breakdown Voltage	BV_{DSS}	$V_{GS} = 0\text{ V}, I_D = 250\ \mu\text{A}$	500	--	--	V
Zero Gate Voltage Drain Current	I_{DSS}	$V_{DS} = 500\text{ V}, V_{GS} = 0\text{ V}$	--	--	1	μA
		$V_{DS} = 400\text{ V}, T_C = 125^\circ\text{C}$	--	--	10	μA
Forward Gate-Source Leakage Current	I_{GSSF}	$V_{GS} = 30\text{ V}, V_{DS} = 0\text{ V}$	--	--	100	nA
Reverse Gate-Source Leakage Current	I_{GSSR}	$V_{GS} = -30\text{ V}, V_{DS} = 0\text{ V}$	--	--	-100	nA

ON

Gate Threshold Voltage	$V_{GS(th)}$	$V_{DS} = V_{GS}, I_D = 250\ \mu\text{A}$	3	--	5	V
Drain-Source On-Resistance	$R_{DS(on)}$	$V_{GS} = 10\text{ V}, I_D = 9\text{ A}$	--	0.25	0.30	Ω
Forward Transconductance ^(Note 4)	g_{FS}	$V_{DS} = 30\text{ V}, I_D = 9\text{ A}$	--	14	--	S

DYNAMIC

Input Capacitance	C_{iss}	$V_{DS} = 25\text{ V}, V_{GS} = 0\text{ V},$ $f = 1.0\text{ MHz}$	--	2880	--	pF
Output Capacitance	C_{oss}		--	283	--	pF
Reverse Transfer Capacitance	C_{rss}		--	10	--	pF

SWITCHING

Turn-On Delay Time ^(Note 4,5)	$t_{d(on)}$	$V_{DD} = 250\text{ V}, I_D = 18\text{ A},$ $R_G = 25$	--	64	--	ns
Turn-On Rise Time ^(Note 4,5)	t_r		--	61	--	ns
Turn-Off Delay Time ^(Note 4,5)	$t_{d(off)}$		--	123	--	ns
Turn-Off Fall Time ^(Note 4,5)	t_f		--	38	--	ns
Total Gate Charge ^(Note 4,5)	Q_g	$V_{DS} = 400\text{ V}, I_D = 18\text{ A},$ $V_{GS} = 10\text{ V}$	--	44	--	nC
Gate-Source Charge ^(Note 4,5)	Q_{gs}		--	14	--	nC
Gate-Drain Charge ^(Note 4,5)	Q_{gd}		--	13	--	nC

SOURCE DRAIN DIODE

Maximum Continuous Drain-Source Diode Forward Current	I_S	---	--	--	18	A
Maximum Pulsed Drain-Source Diode Forward Current	I_{SM}	---	--	--	72	A
Drain-Source Diode Forward Voltage	V_{SD}	$V_{GS} = 0\text{ V}, I_S = 18\text{ A}$	--	--	1.5	V
Reverse Recovery Time ^(Note 4)	t_{rr}	$V_{GS} = 0\text{ V}, I_S = 18\text{ A}$	--	421	--	ns
Reverse Recovery Charge ^(Note 4)	Q_{rr}	$di_F / dt = 100\text{ A}/\mu\text{s}$	--	5.9	--	μC

Note :

1. Repeated rating : Pulse width limited by safe operating area
2. $L=4.6\text{mH}, I_{AS} = 18\text{A}, V_{DD} = 50\text{V}, R_G = 25$, Starting $T_j = 25$
3. $I_{SD} = 18\text{A}, di/dt = 100\ \mu\text{s}, V_{DD} = 50\text{V}, V_{DS} = 400\text{V}$, Starting $T_j = 25$
5. Essentially Independent of Operating Temperature Typical Characteristics

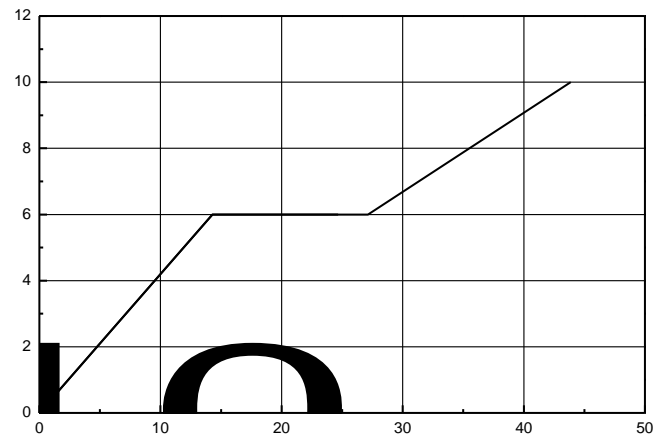
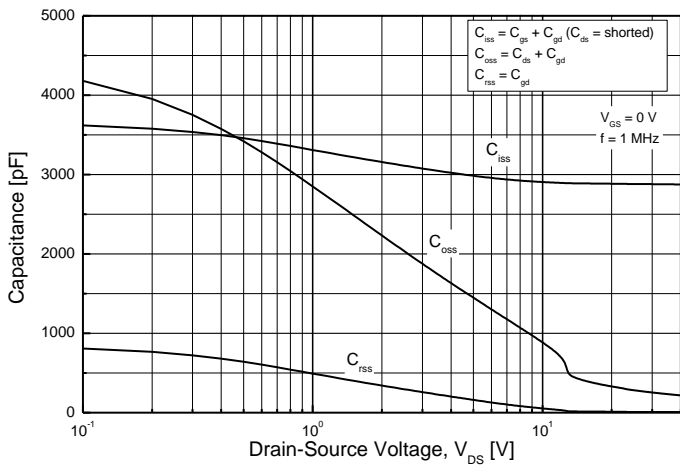
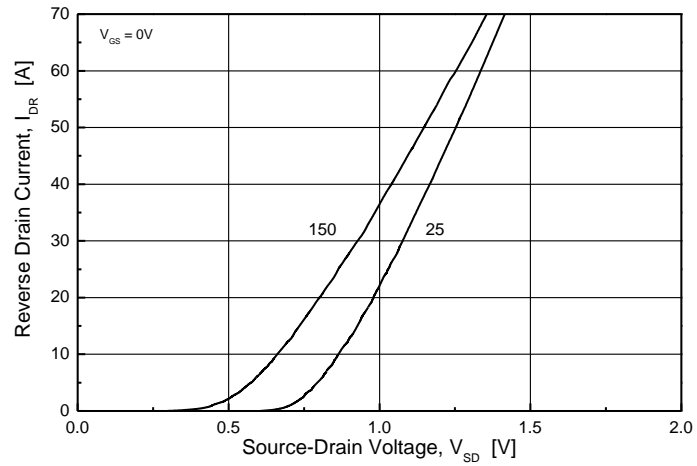
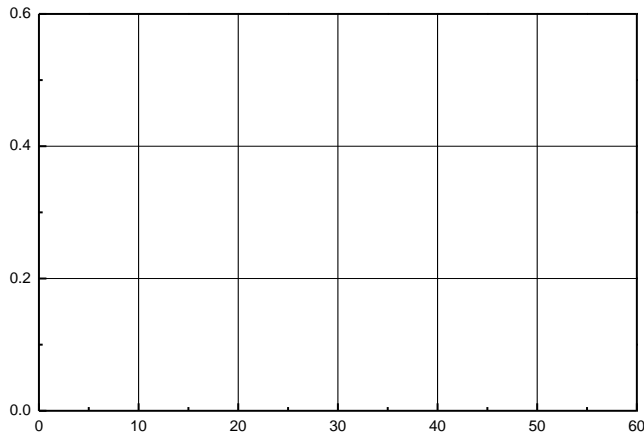
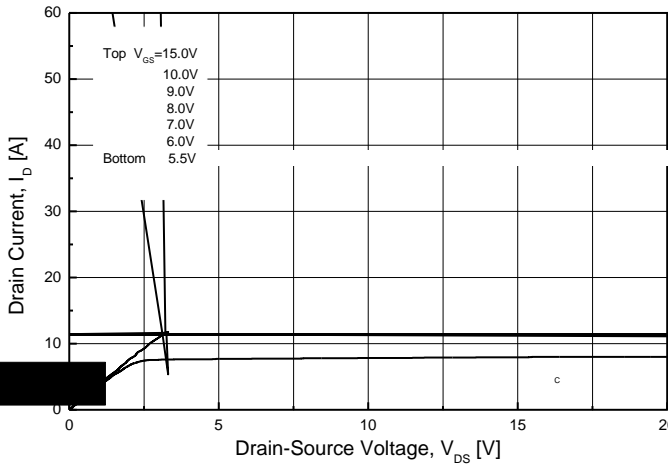

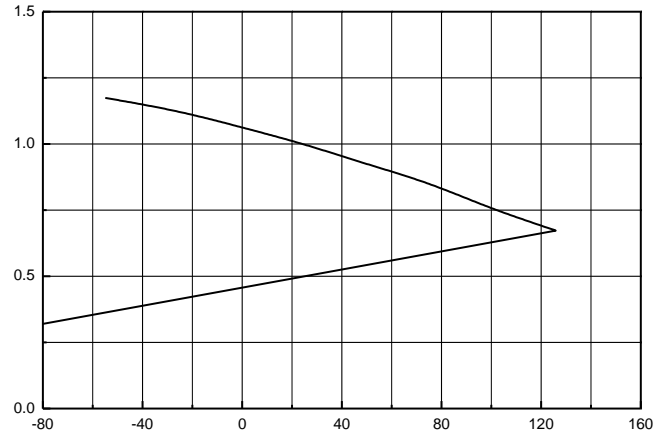
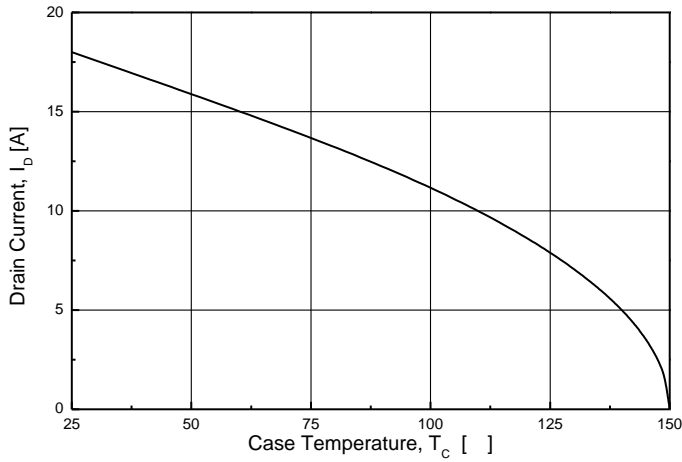
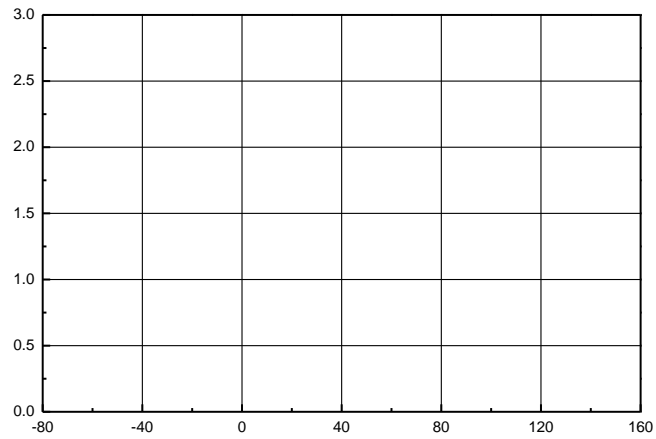
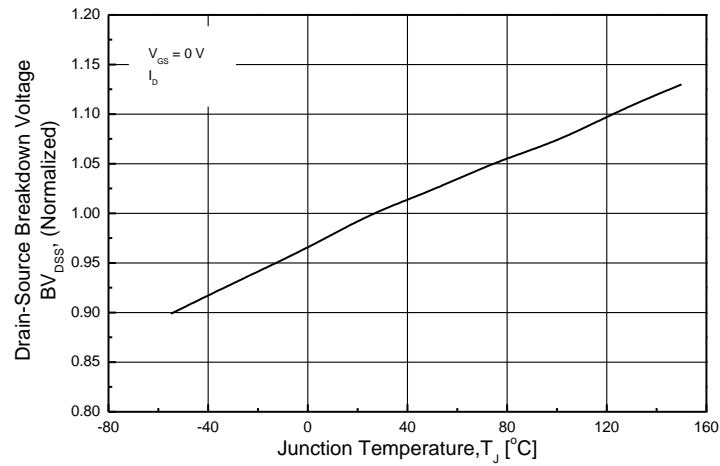

TMP20N50A(G)

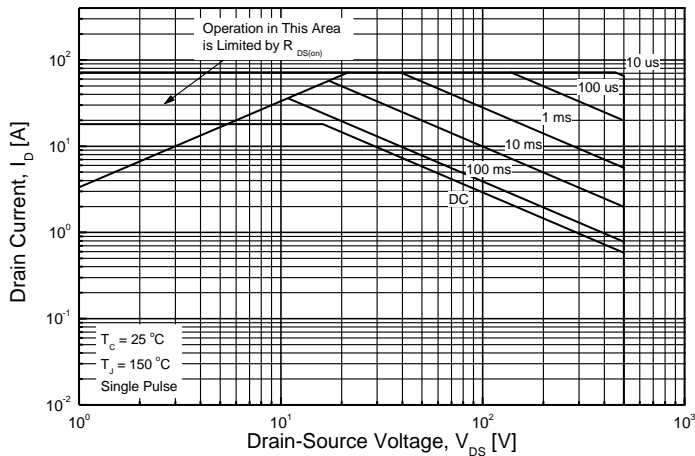

TMPF20N50A(G)

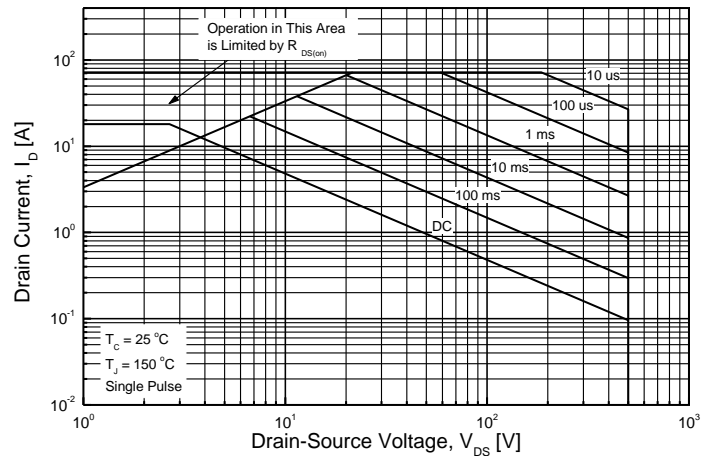

TMP20N50A(G)



TMPF20N50A(G)

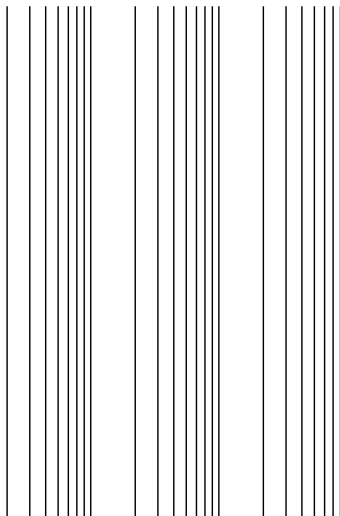

TO-220AB-3L MECHANICAL DATA

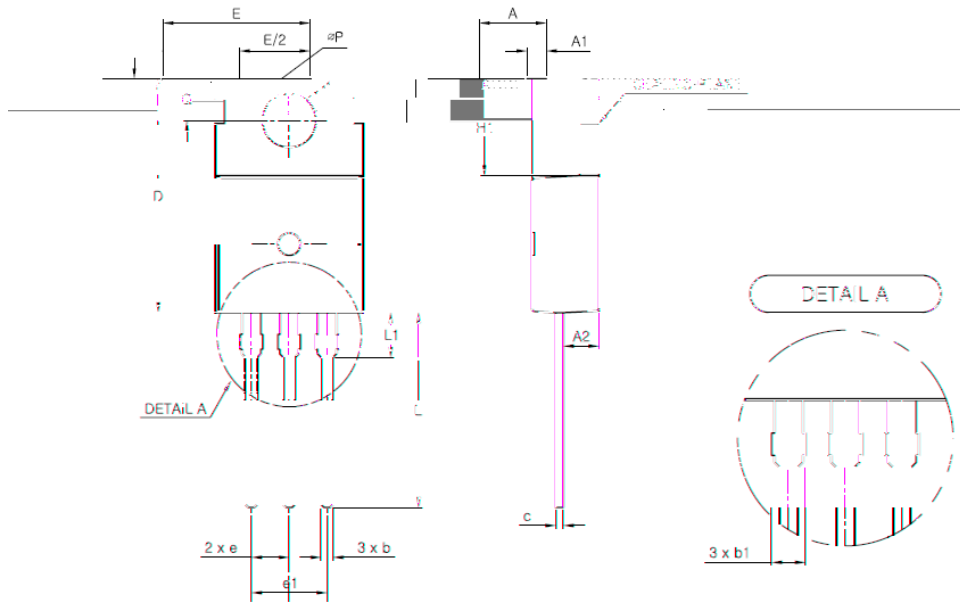

SYMBOL	MIN	MAX
A	4.30	4.70
A1	1.22	1.40
A2	2.20	2.79
b	0.70	0.91
b1	1.15	1.62
c	0.36	0.60
D	14.99	15.90
E	9.70	10.41
e	2.54 TYP	
e1	5.08 BSC	
H1	5.97	6.70
L	12.88	13.97
L1	3.31	3.81
ØP	3.40	3.88
Q	2.60	2.90

TO-220F-3L MECHANICAL DATA

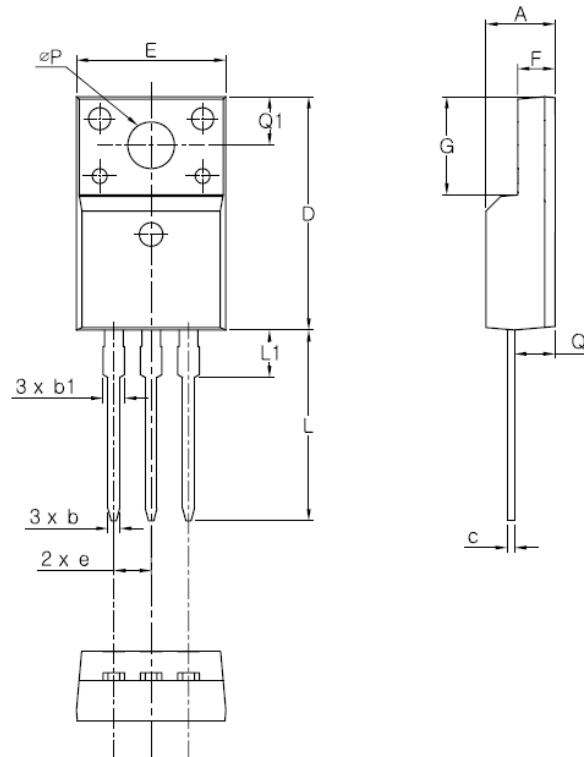

Disclaimer :

TRinno technology reserves the right to make changes without notice to products herein to improve reliability, performance, or design. The information given in this document is believed to be accurate and reliable. However, it shall in no event be regarded as a guarantee of conditions and characteristics. With respect to any information regarding the