

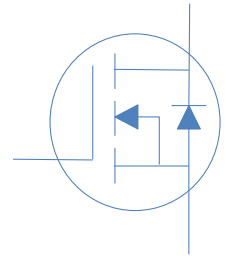

| | | | |
|--|--|--|----------|
| | | | |
| | | | Ω |
| | | | Ω |
| | | | |



| | | |
|--|--|--|
| | | |
| | | |

| | | | |
|--|--|--|--|
| | | | |
| | | | |
| | | | |
| | | | |
| | | | |
| | | | |
| | | | |
| | | | |
| | | | |

| | | |
|--|---|--|
| | | |
| | e | |
| | e | |



| | | | | | | |
|--|--|-------|--|--|--|----------|
| | | | | | | |
| | | | | | | |
| | | μ | | | | |
| | | μ | | | | |
| | | | | | | μ |
| | | | | | | |
| | | | | | | Ω |
| | | | | | | Ω |
| | | | | | | Ω |

| | | | | | | |
|--|--|----------|--|--|--|--|
| | | | | | | |
| | | | | | | |
| | | | | | | |
| | | | | | | |
| | | | | | | |
| | | | | | | |
| | | | | | | |
| | | | | | | |
| | | | | | | |
| | | Ω | | | | |
| | | | | | | |
| | | | | | | |

| | | | | | | |
|--|--|--|-------|--|--|--|
| | | | | | | |
| | | | | | | |
| | | | μ | | | |
| | | | | | | |

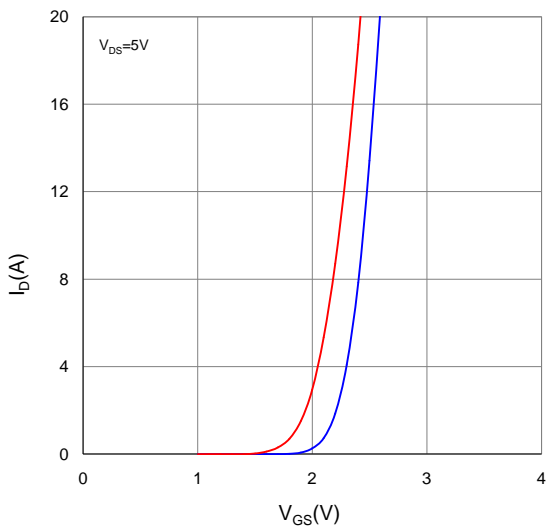
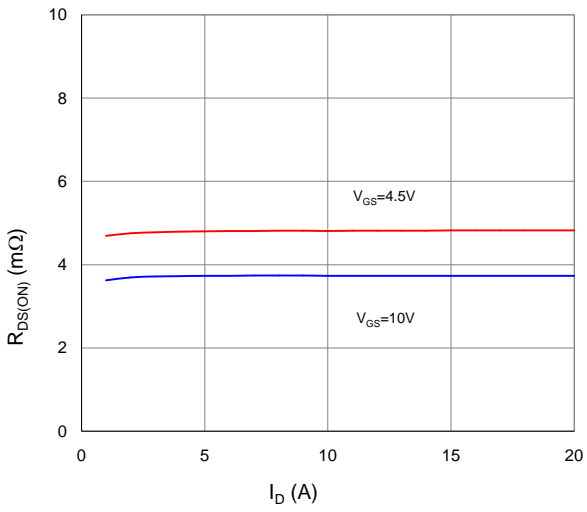
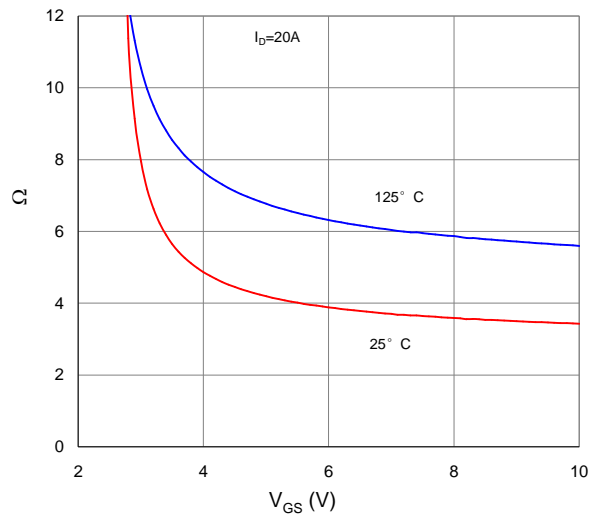
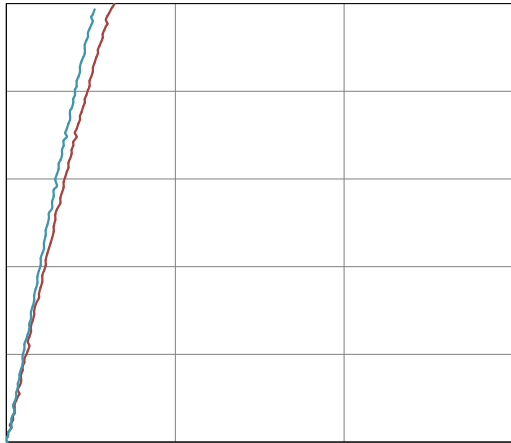

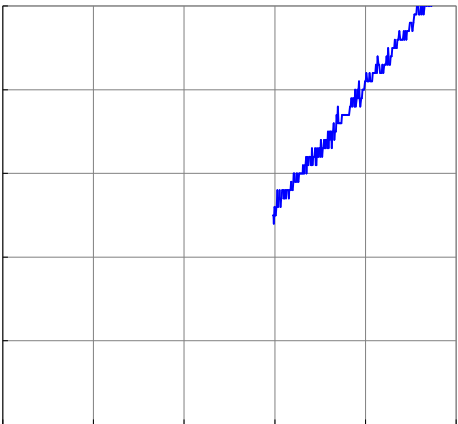

| | |
|---|--|
| | |
|  | |

| | |
|--|--|
| | |
| | |

| |
|--|
| |
| |



| | |
|--|--|
| | |
| | |
| | |
| | |
| | |
| | |

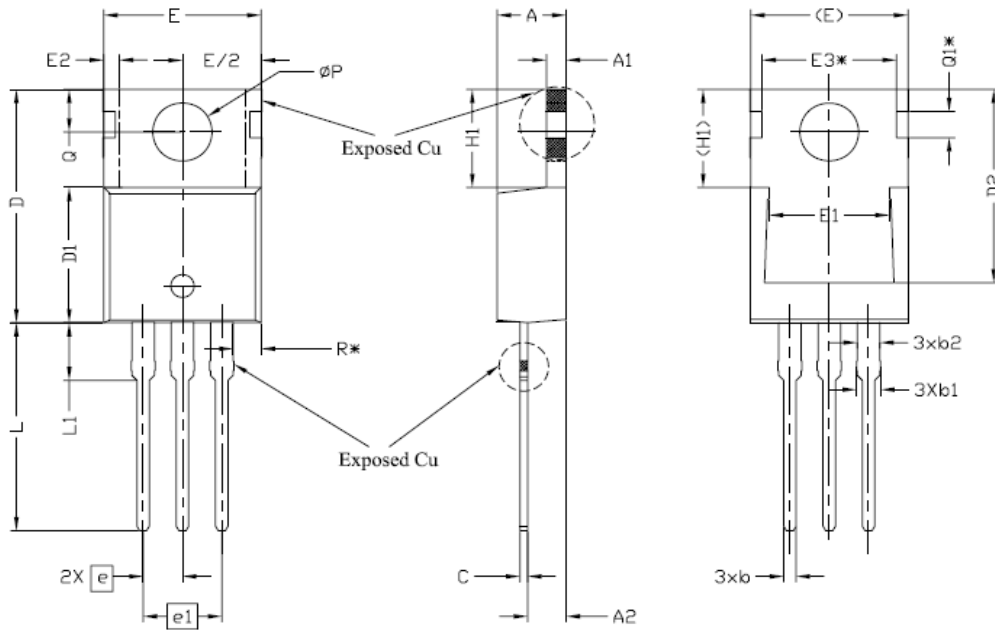

| SYMBOL | DIMENSIONS | | | NOTES |
|--------|------------|-------|-------|-------|
| | MIN. | NOM. | MAX. | |
| A | 4,24 | 4,44 | 4,64 | |
| A1 | 1,15 | 1,27 | 1,40 | |
| A2 | 2,30 | 2,48 | 2,70 | |
| b | 0,70 | 0,80 | 0,90 | |
| b1 | 1,20 | 1,55 | 1,75 | |
| b2 | 1,20 | 1,45 | 1,70 | |
| c | 0,40 | 0,50 | 0,60 | |
| D | 14,70 | 15,37 | 16,00 | 4 |
| D1 | 8,82 | 8,92 | 9,02 | |
| D2 | 12,63 | 12,73 | 12,83 | 5 |
| E | 9,96 | 10,16 | 10,36 | 4,5 |
| E1 | 6,86 | 7,77 | 8,89 | 5 |
| E2 | - | - | 0,76 | 6 |
| E3* | 8,70REF. | | | |
| e | 2,54BSC | | | |
| e1 | 5,08BSC | | | |
| H1 | 6,30 | 6,45 | 6,60 | 5,6 |
| L | 13,47 | 13,72 | 13,97 | |
| L1 | 3,60 | 3,80 | 4,00 | |
| ØP | 3,75 | 3,84 | 3,93 | |
| Q | 2,60 | 2,80 | 3,00 | |
| Q1* | 1,73REF. | | | |
| R* | 1,82REF. | | | |