



=25°C

°C

°C/W

°C/W



=25°C (unless otherwise specified)

			=25°C			
			=100°C			
		=±20V, V				±

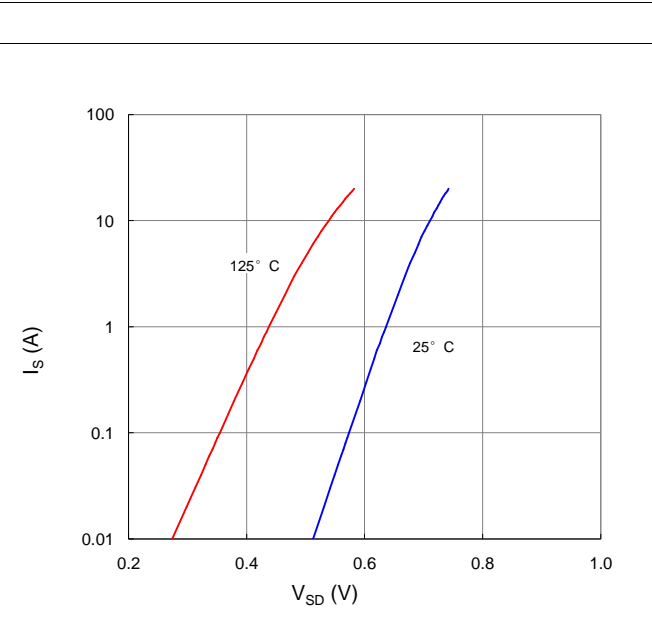
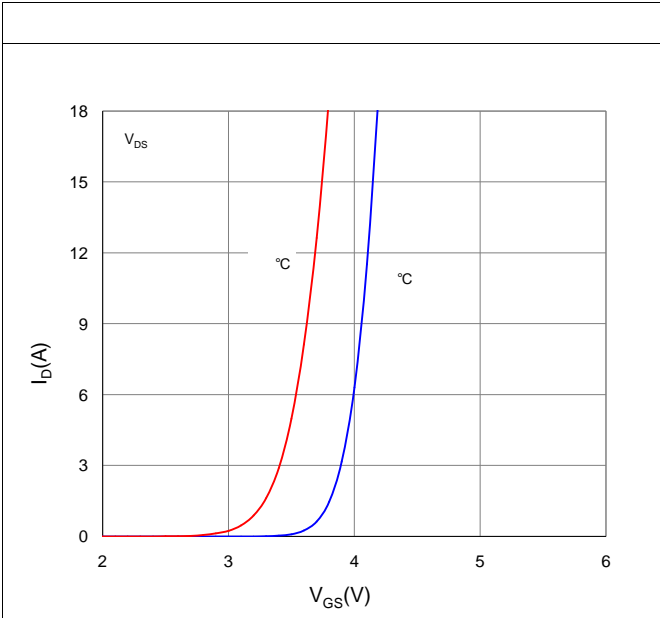
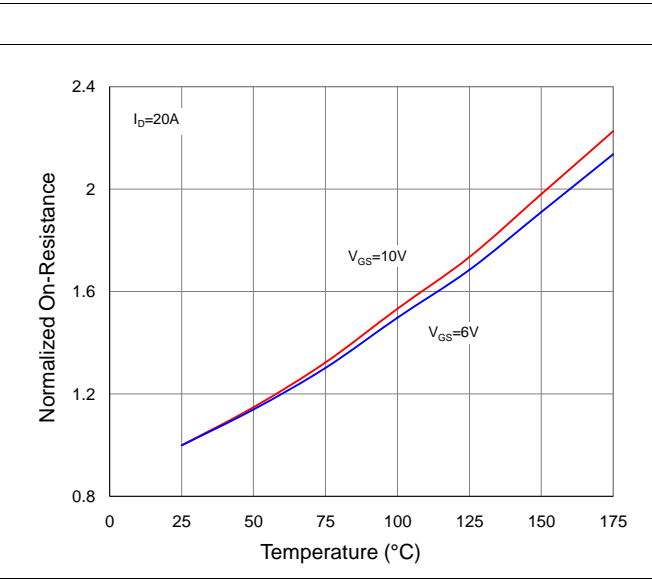
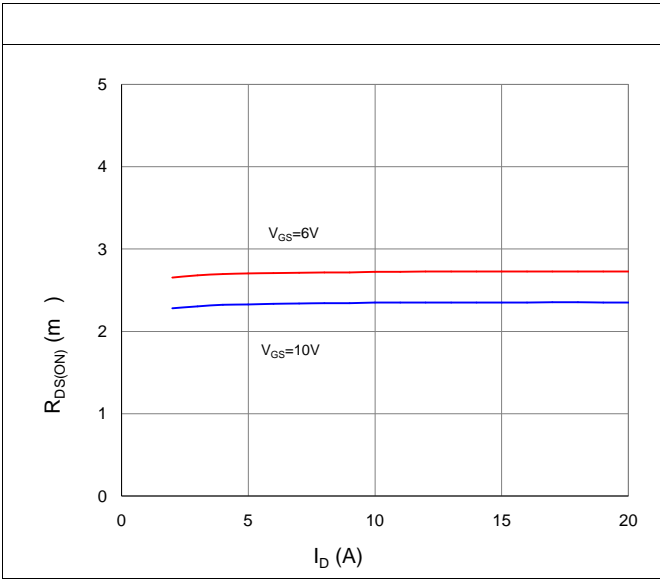
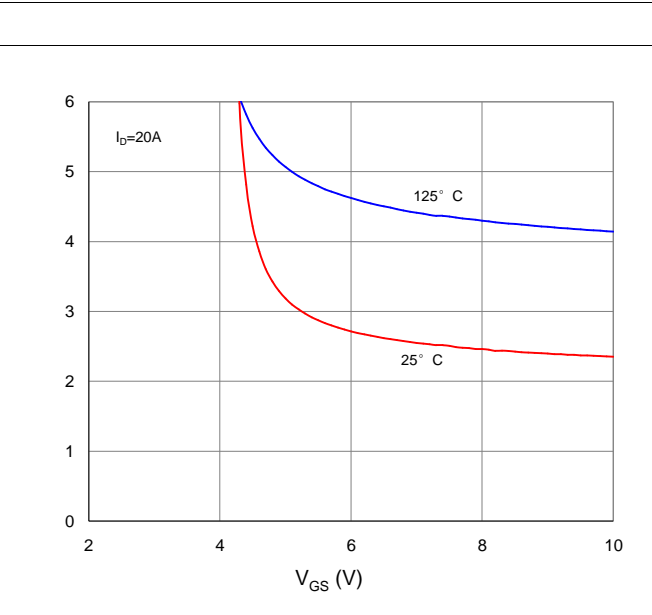
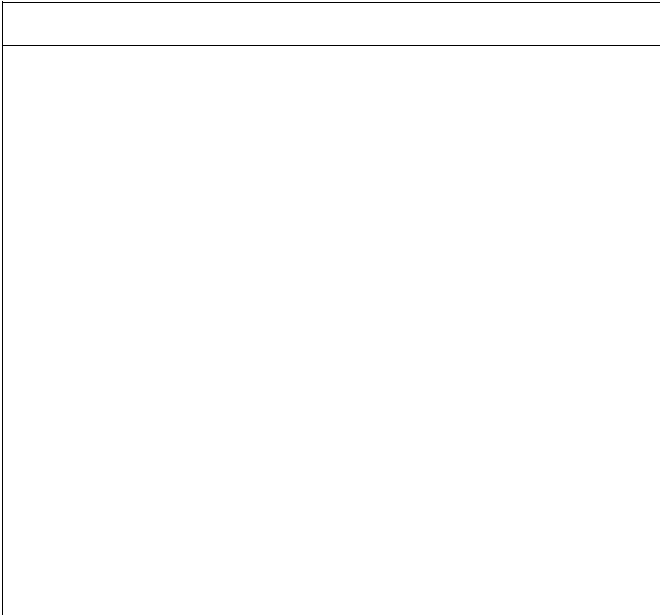

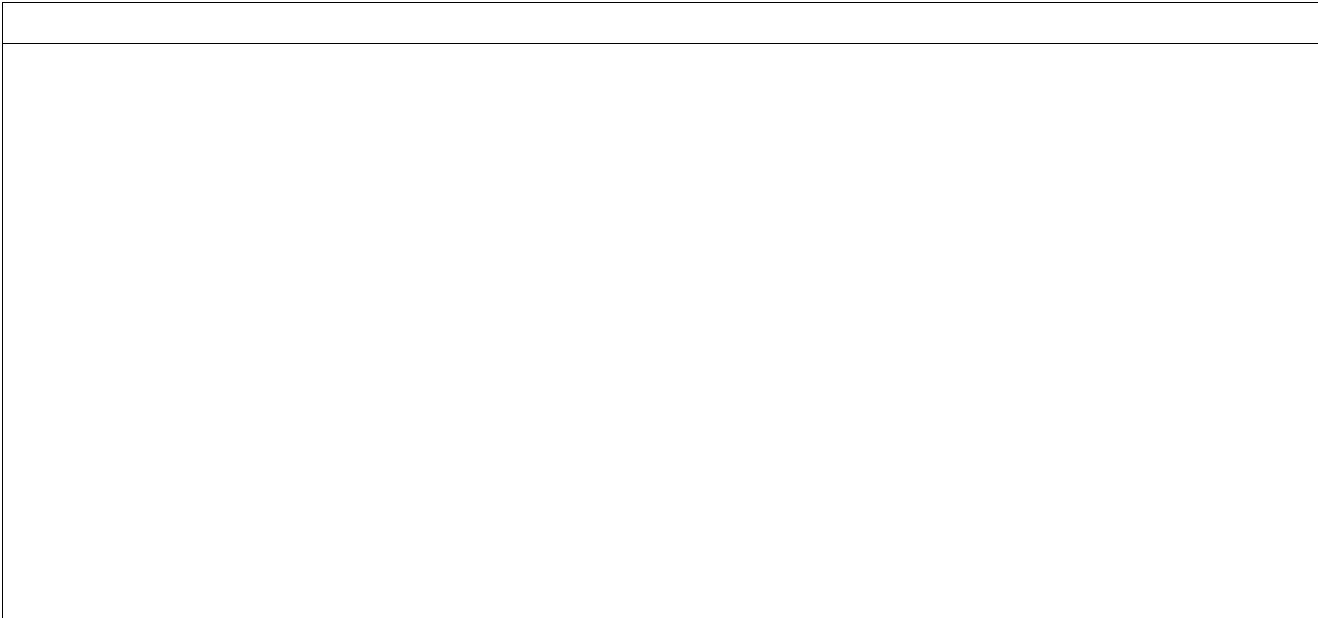
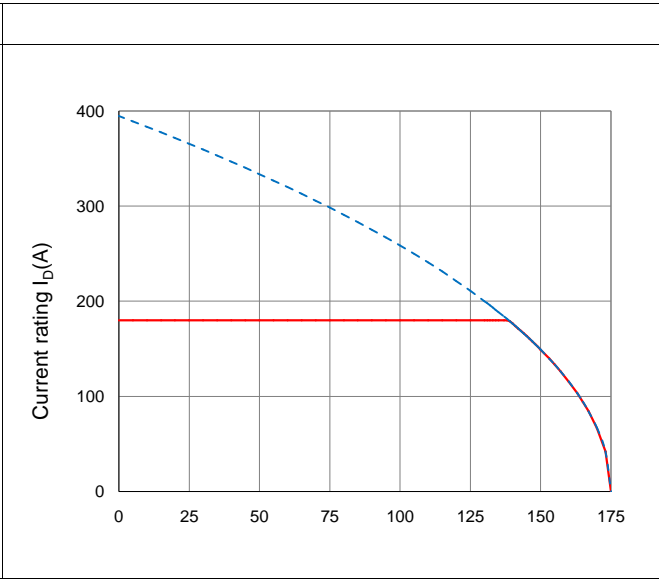
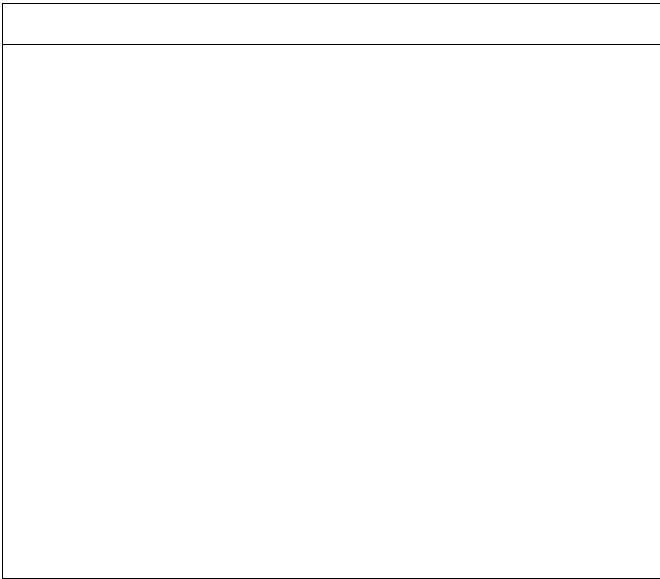
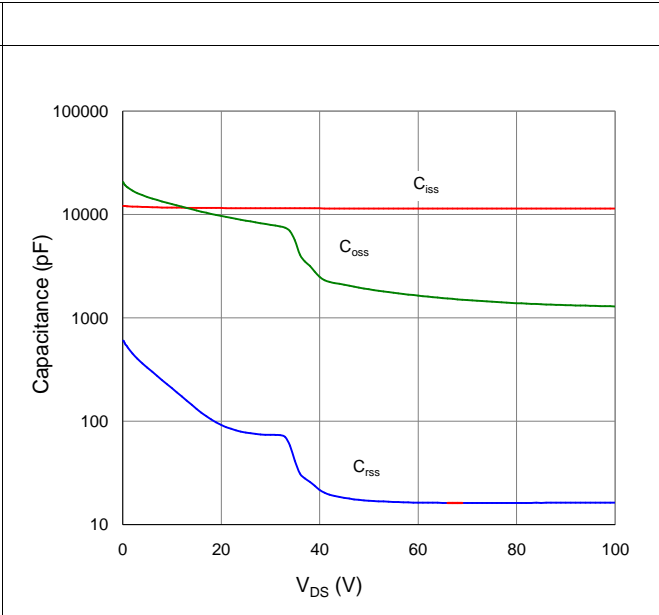
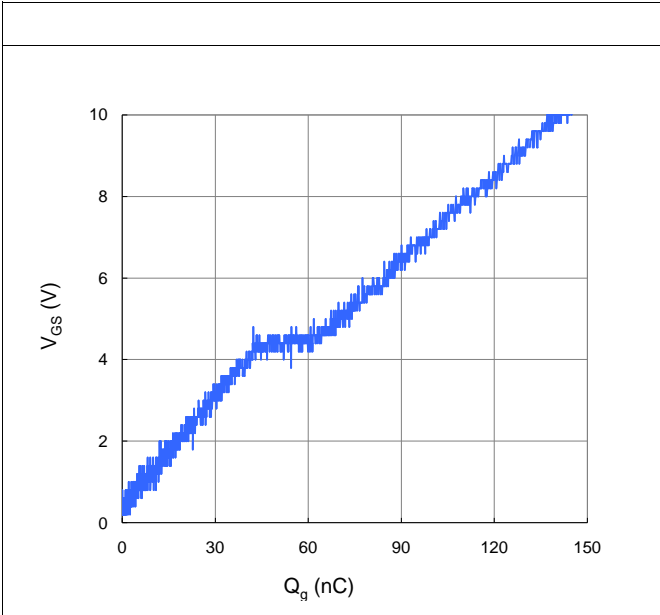

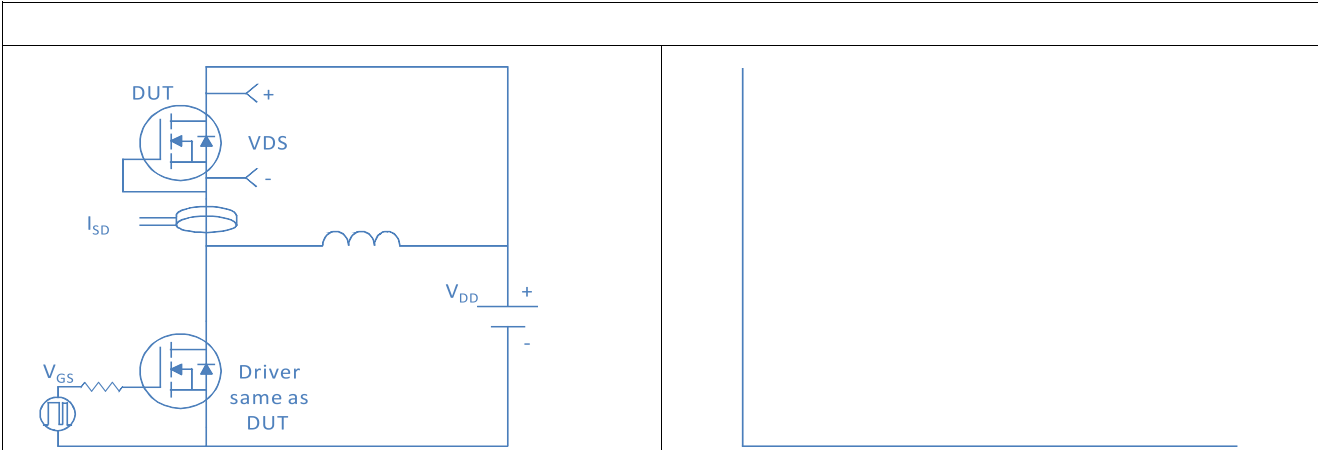
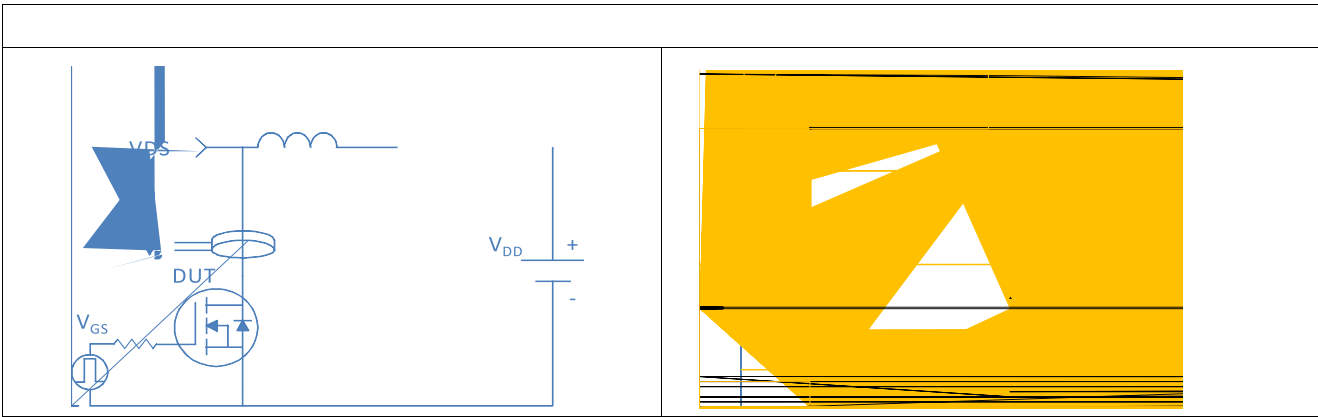
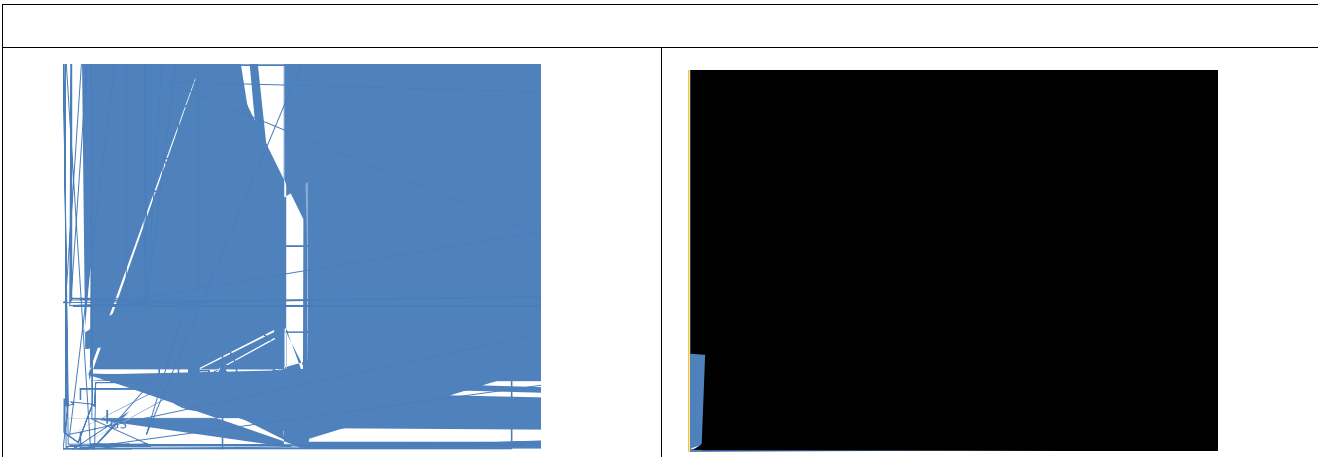
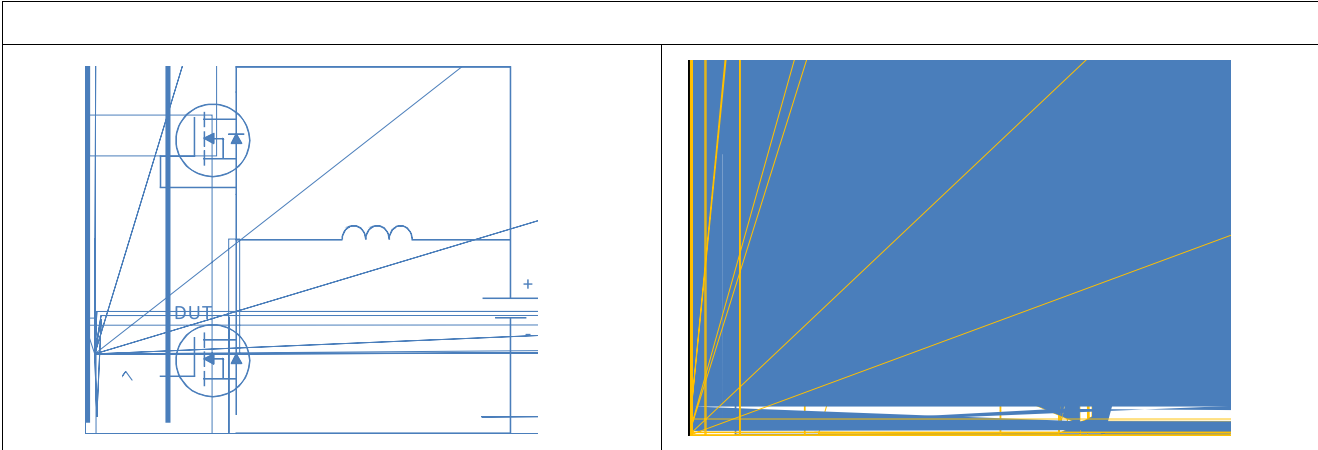

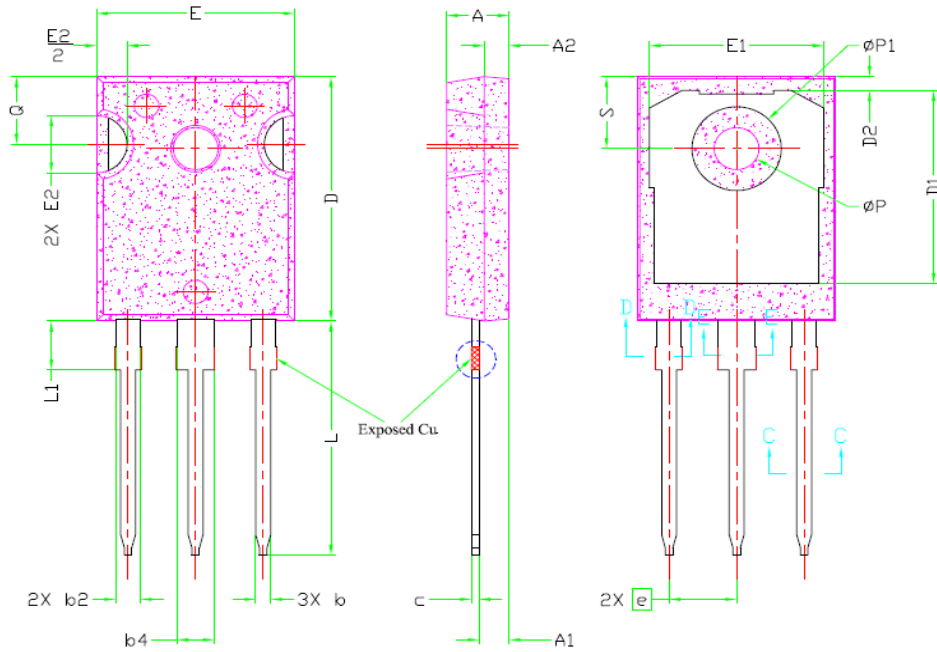

SYMBOL	DIMENSIONS			NOTES
	MIN.	NOM.	MAX.	
A	4.82	5.02	5.04	
A1	2.14	2.29	2.41	
A2	2.14	2.29	2.41	
B	0.50	0.50	0.50	
B1	0.50	0.50	0.50	
B2	0.50	0.50	0.50	
C	0.10	0.10	0.10	
D	1.27	1.27	1.27	
D1	1.27	1.27	1.27	
D2	1.27	1.27	1.27	
E	10.16	10.16	10.16	
E1	10.16	10.16	10.16	
E2	10.16	10.16	10.16	
F	1.27	1.27	1.27	
F1	1.27	1.27	1.27	
F2	1.27	1.27	1.27	
G	1.27	1.27	1.27	
H	1.27	1.27	1.27	
I	1.27	1.27	1.27	
J	1.27	1.27	1.27	
K	1.27	1.27	1.27	
L	1.27	1.27	1.27	
M	1.27	1.27	1.27	
N	1.27	1.27	1.27	
O	1.27	1.27	1.27	
P	1.27	1.27	1.27	
Q	1.27	1.27	1.27	